

# Brake Kit Instructions

For Models: T, J and H

### APPLICATION

This wiring modification is available for models T, J and H. Brake kit for all 115, 208, 230/460 and 575V operators.

### BRAKE FUNCTIONS

Ensure your brake kit matches your operator. The kit will provide up to 5 lb.-ft. of braking torque at 1725 RPM motor shaft.

### VOLTAGE REQUIREMENTS

#### Models T and J

71B120 For operators with 115V incoming power source.

71B208 For operators with 208V incoming power source.

**NOTE:** For logic operators, 40VA upgrade kit 71-902140VAL must be installed.

71B240 For operators with 230V and 460V incoming power source.

71B575 For operators with 575V incoming power source.

#### Model H

71B120H For operators with 115V incoming power source.

71B208H For operators with 208V incoming power source.

**NOTE:** For logic operators, 40VA upgrade kit 71-902140VAL must be installed.

71B240H For operators with 230V and 460V incoming power source.

71B575H For operators with 575V incoming power source.

### INSTALLATION

1. Disconnect power to operator.
2. Remove 2" pulley on motor shaft and belt.
3. Refer to brake plate spacing requirements on page 2 to determine proper spacing necessary for the motor used on operator.
4. With spacers added to motor studs, slide brake hub with life seal onto motor shaft. Position brake hub 1/8" from motor hub (Figure 1). Install longer key and secure with set screw provided.
5. Slide brake assembly over motor shaft. Align 4 holes in brake mounting plate with motor studs and secure each stud with a flange nut. If the holes do not line up, push in actuating arm and you will find the side to side place that is needed.
6. Add 2" pulley to shaft. Loosen motor mounting bolts to allow for pulley alignment. Using a ruler or straight edge, align large and small pulleys.
7. Install belt and, with pulleys aligned, secure with set screws. Retighten motor mounting bolts to secure belt.

### ⚠️ WARNING

To prevent possible SERIOUS INJURY or DEATH, disconnect electric power to operator BEFORE installing.  
ALL installations and electrical connections MUST be made by a qualified individual.

### CARTON INVENTORY

DESCRIPTION	QTY
Instructions . . . . .	1
Solenoid Cover. . . . .	1
Conduit, 3/8" X 16" Long . . . . .	1
Anti-Short Bushing . . . . .	2
Conduit Connector 90 Degree Double . . . . .	1
Spacer, .20 I.D. X .31 Long . . . . .	4
Spacer, #10 X .31 Long . . . . .	4
Brake Spacer Bolt . . . . .	4
Brake Hub Assembly . . . . .	1
Brake Kit Sub Assembly. . . . .	1
Key, 3/16" Square X 1-3/4" Long . . . . .	1
Screw, #10-32 Ph HH Tap Tite . . . . .	1
Flange Nut, #8 . . . . .	1
Flange Nut, #10 . . . . .	4
Flatwasher, #10 . . . . .	8
Brake Release Cable Kit (Model H Brake Kits Only) . . . . .	8
Wire Bl/Bk 16GA 42" 3/16" INS. Faston X Strip . . . . .	4
Push Retaining Ring, 5/8" . . . . .	1

8. Remove connector on motor and replace with the double connector. On single phase motors it will be necessary to remove screws from capacitor cover. This will enable you to screw the connector on the motor freely. Replace cover when completed. Use the original single connector from motor on the brake.
9. Using conduit and anti-short bushing provided, wire the brake solenoid as shown in the motor connection diagrams on page 2. Secure conduit connectors.
10. Install solenoid cover and secure using screws #10 provided.

FIGURE 1

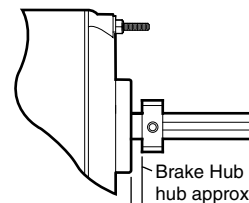

Brake Hub must be offset from the motor hub approximately 1/8" and fastened in place with the key and set screw provided.

# BRAKE PLATE SPACING REQUIREMENTS

## AO SMITH MOTORS

There are four threaded thru-bolts that protrude on the shaft side of the motor and are fastened with existing hex nuts #8-32. Add one spacer and one flange nut #8-32 to each thru-bolt (Figure 2).

## DOERR/BALDOR (ODP) MOTORS

There are four threaded thru-bolts that protrude on the shaft side of the motor and are fastened with existing hex nuts #10-32. Add one flatwasher #10 and one flange nut #10-32 to each thru-bolt (Figure 3).

## BALDOR (TEFC) MOTORS

There are four threaded thru-bolts that protrude on the shaft side of the motor and are fastened with existing hex nuts #10-32. Add one spacer, one flatwasher #10 and one flange nut #10-32 to each thru-bolt (Figure 4).

## EMERSON MOTORS

There are four threaded thru-bolts that protrude on the shaft side of the motor and are fastened with existing hex nuts #8-32. Add one flange nut #8-32 to each thru-bolt (Figure 5).

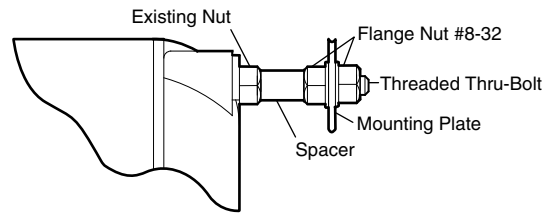

FIGURE 2

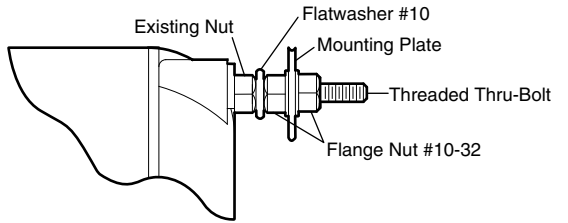

FIGURE 3

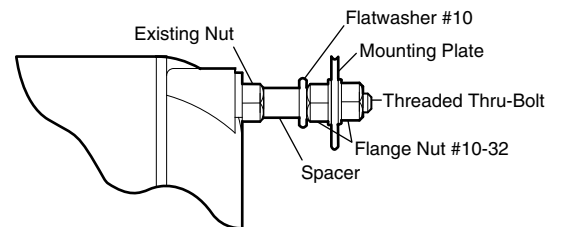

FIGURE 4

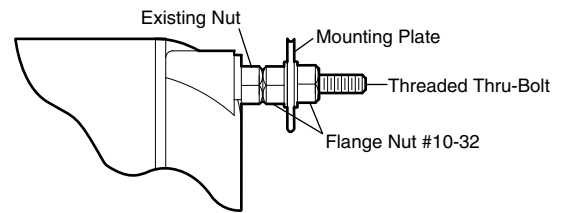
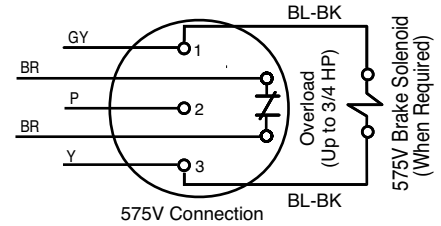
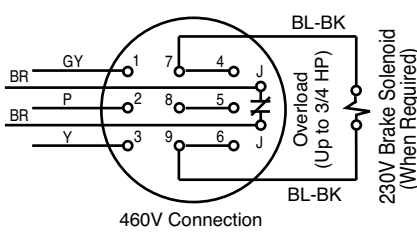
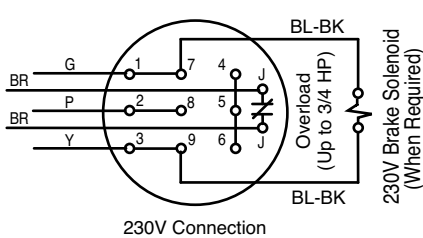

FIGURE 5

# MOTOR CONNECTION DIAGRAMS

## THREE PHASE



## SINGLE PHASE

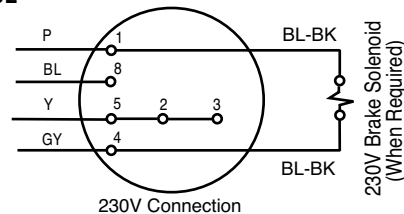
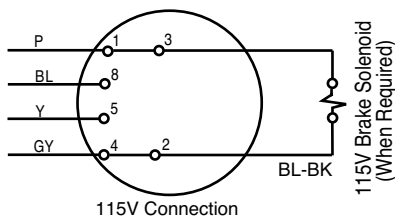

# BRAKE ASSEMBLY

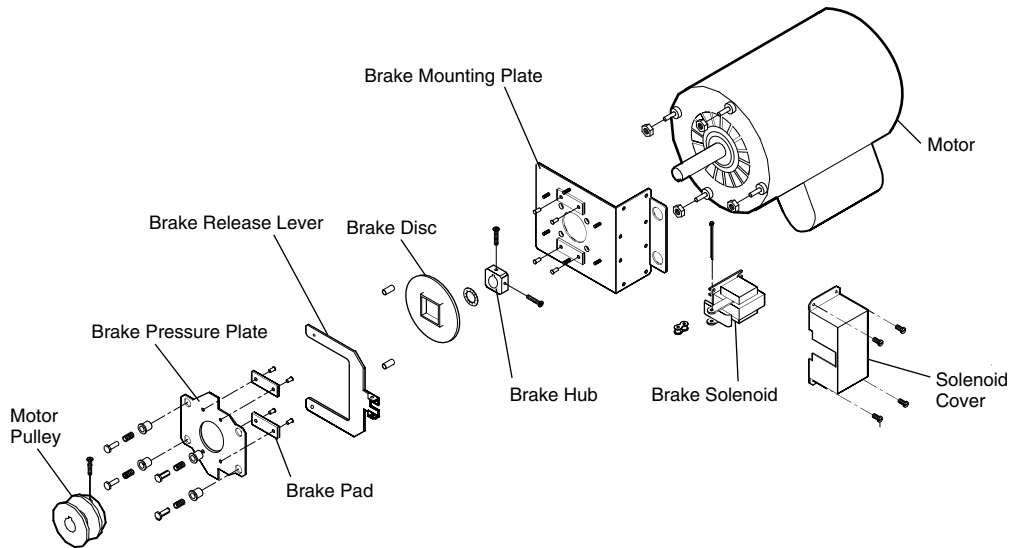

## RELEASE CABLE INSTALLATION

1. Locate the screw threads protruding through the brake mounting plate opposite the brake solenoid. Mount the new cable clamp to the thread that is second from the top and closest the motor. Secure in place with the #10 flange nut provided.
2. Locate the release cable, cable sleeving and (2) spring clamps. Install the two spring clamps onto one end of the sleeving. Feed the release cable from the side without the spring into the sleeving from the side with the spring clamps.
3. Take the release cable assembly and feed the release cable and sleeving through the cable clamp installed in step 1 and through the top hole of the brake mounting plate. Once you get to the brake release lever, feed only the release cable through the top hole. Secure in place by installing a flatwasher #8 and a 1/16" cable stop sleeve. Secure cable stop sleeve in place by crimping down on it with pliers (Figure 6).
4. Locate the frame spacer that has the release chain going through it. Take the end of the cable sleeving with the two spring clamps and slide it down into the notch in the center of the bracket (be sure that one spring clamp is on each side of bracket). Release the clamps and slide the sleeving until at least 3" protrudes out past the bracket. Secure in place by sliding the clamps as tight to the bracket as possible (Figure 7).
5. Pull release chain and release cable so that both are taunt, being careful not to engage either of the two. Connect the two together using the key ring on the end of the spring.
6. Reconnect power to operator.

## TEST BRAKE RELEASE

After the installation is complete, pull the release chain to ensure the brake disengages. If the brake does not fully disengage, it can be adjusted by hooking the key ring further away from the operator. Move the key ring one chain link at a time, testing each time (Figure 8).

FIGURE 6

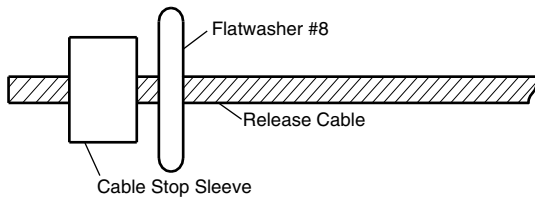

FIGURE 8

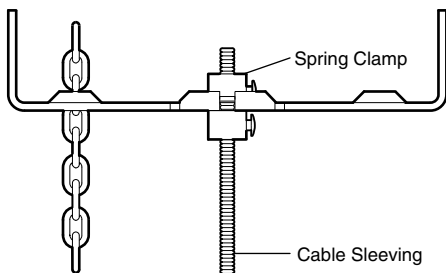

FIGURE 7

