

** CUT TOP PANEL TO SIZE BEFORE MOUNTING TOP FIXTURES 7-3/4" MIN. DOOR HEIGHT (WOOD ONLY) TO BE OPENING HEIGHT MINUS 7/8"

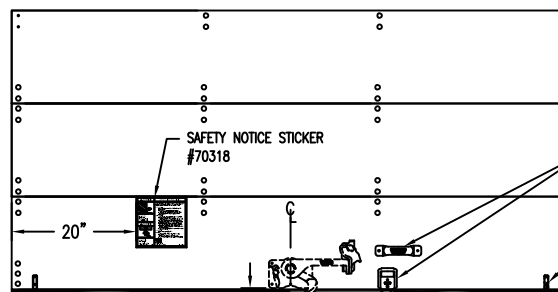

MS LOCK #69571 & KEEPER #69572 SENT LOOSE MOUNT MS LOCK ON C/L OF PANEL & UP 1/4" UP FROM BOTTOM OF PANEL USING FIVE 1-1/8" SEMI-TUBULAR RIVETS THREE 1-1/8" SEMI-TUBULAR RIVETS REQUIRED FOR KEEPER

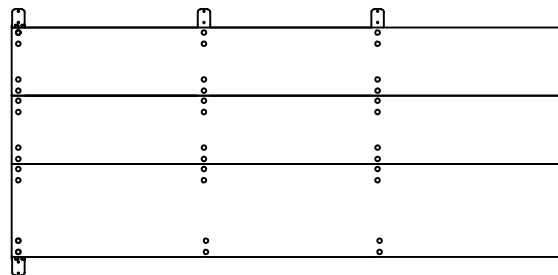
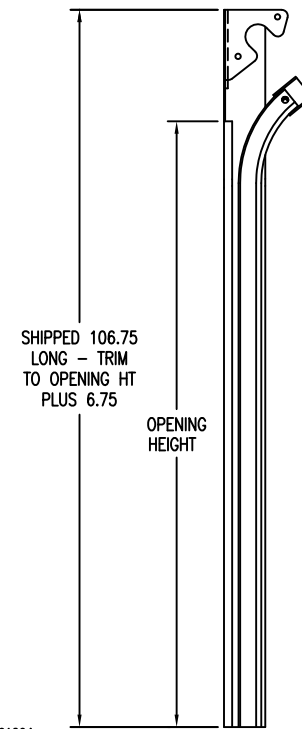

VERTICAL TRACK DETAIL

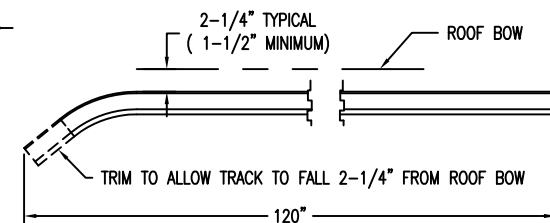

HORIZONTAL TRACK

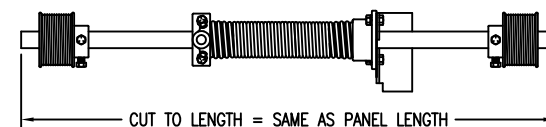

COUNTERBALANCE ASSEMBLY

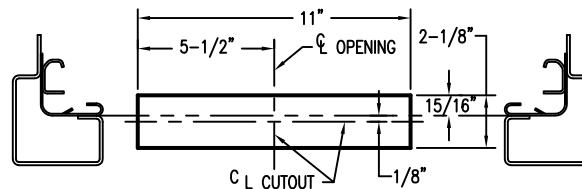

DETAIL OF CUTOUT IN SILL FOR 70093 LOCK CATCH BOX

KIT #99610-1 COMPLETE DOOR, TRACK & C/B TO FIT MAX. OPEN. WIDTH 87-3/4" X 90-100"HT.
KIT #99610-2 DOOR ONLY, DOES NOT INCLUDE ITEMS MARKED *

ITEM	PART No.	DESCRIPTION	QTY
1	-	3/4" WOOD DOOR - 90" W X 99-3/4" H	1
*2	49014-003416	VERTICAL TRACK ASSEMBLY 106-3/4" LONG	1 PAIR
*3	50113-003840	HORIZONTAL TRACK - 120" LONG - 6" R, 7"HRC	1 PAIR
*4	59174-0357X90	COUNTERBALANCE - #3x1.75x57 - 90" SHAFT	1
5	69035-0000	END HINGE	6
6	69431-0000	TOP FIXTURE SLIDE	2
7	69571-0000-05	MAXIMUM SECURITY LOCK (E-COATED)	1
8	69572-0000-05	MAXIMUM SECURITY LOCK KEEPER (E-COATED)	1
9	51044-0000	110" CABLE ASSEMBLY	1 PAIR
10	69770-2808	HEAD SEAL ASSEMBLY, 87-3/4" LONG	1
11	89319-3000	ROLLER KIT - 16 STEEL ROLLERS	1
12	70093-0000	MS LOCK CATCH BOX	1
13	89307-1000	UNIVERSAL DOOR HARDWARE KIT	1
14	61390-3456	RUBBER SIDE SEAL - 108"	2
15	70405-0000	TODCO DOOR OWNERS MANUAL	1

NOTICE OF PROPRIETARY RIGHTS
THE DRAWING AND/OR TECHNICAL INFORMATION ON THIS SHEET IS THE PROPERTY OF OVERHEAD DOOR CORPORATION OR ITS SUBSIDIARY AND IS LOANED IN CONFIDENCE FOR ENGINEERING AND MUTUAL ASSISTANCE PURPOSES ONLY, AND MAY NOT BE REPRODUCED OR USED TO MANUFACTURE ANYTHING, DISCLOSED HEREIN WITHOUT THE EXPRESS PERMISSION OF OVERHEAD DOOR CORPORATION WHICH MAY RECALL THIS SHEET AT ANY TIME.

NO.	REVISION	DATE	DR.	PART NO.	DWG. NO.
D	UPDATED FOR IMPROVED PACKAGING METHOD - UPDATE BOM AS NEEDED	01.18.18	MY	 MARION, OHIO DESCRIPTION UNIVERSAL DOOR KIT - OPENINGS TO 87-3/4" W x 90-100" H MATERIAL DR. BY: J. GALBREATH FINISH DATE: 01-18-78	C-99610-D
C	ADDED 70318 & 70319	04.25.95	JB		
B	REDRAWN & REVISED-CAD	02.01.94	RM		
A	WAS 61174 ROLLER	04.21.93	AD		