

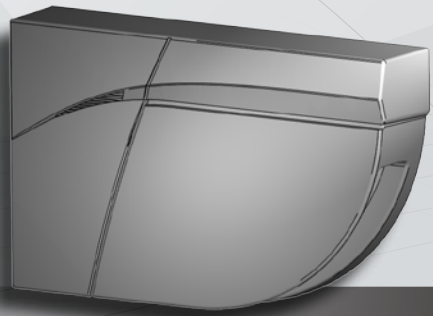

EN



Watch our FLATSCAN SW tutorial online: [bea-flatscan.com/tutorial](http://bea-flatscan.com/tutorial)



# LZR<sup>®</sup> -FLATSCAN SW

SAFETY SENSOR  
FOR AUTOMATIC SWING DOORS



User's Guide for product version 0201 and higher  
See product label for serial number

## INSTALLATION TIPS

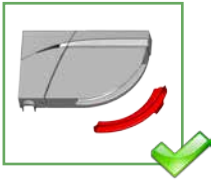

Remove the laser window protection before the teach-in and the commissioning of the sensor.



Avoid vibrations.



Do not cover the laser window.



Avoid moving objects and light sources in the detection field.



Avoid the presence of smoke and fog in the detection field.



Avoid condensation.

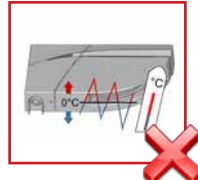

Avoid exposure to sudden and extreme temperature changes.

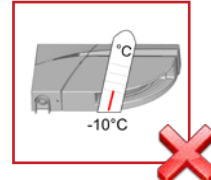

Keep the sensor permanently powered in environments where the temperature can descend below -10°C.

## MAINTENANCE TIPS



When needed, wipe the laser window only with a soft, clean and damp microfibre cloth.



Do not use dry or dirty towels or aggressive products to clean the laser window.



Avoid direct exposure to high pressure cleaning.



The warranty is invalid if unauthorized repairs are made or attempted by unauthorized personnel.

## SAFETY TIPS

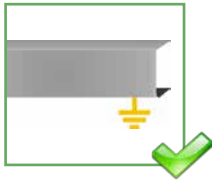

The door control unit and the door cover profile must be correctly earthed.



Only trained and qualified personnel may install and setup the sensor.



Always test the good functioning of the installation before leaving the premises.



Do not remove the laser window protection if building works are still in progress on site.

- ⚠ The device cannot be used for purposes other than its intended use. All other uses cannot be guaranteed by the manufacturer of the sensor.
- The manufacturer of the door system is responsible for carrying out a risk assessment and installing the sensor and the door system in compliance with applicable national and international regulations and standards on door safety.
- The manufacturer of the sensor cannot be held responsible for incorrect installations or inappropriate adjustments of the sensor.

## DESCRIPTION

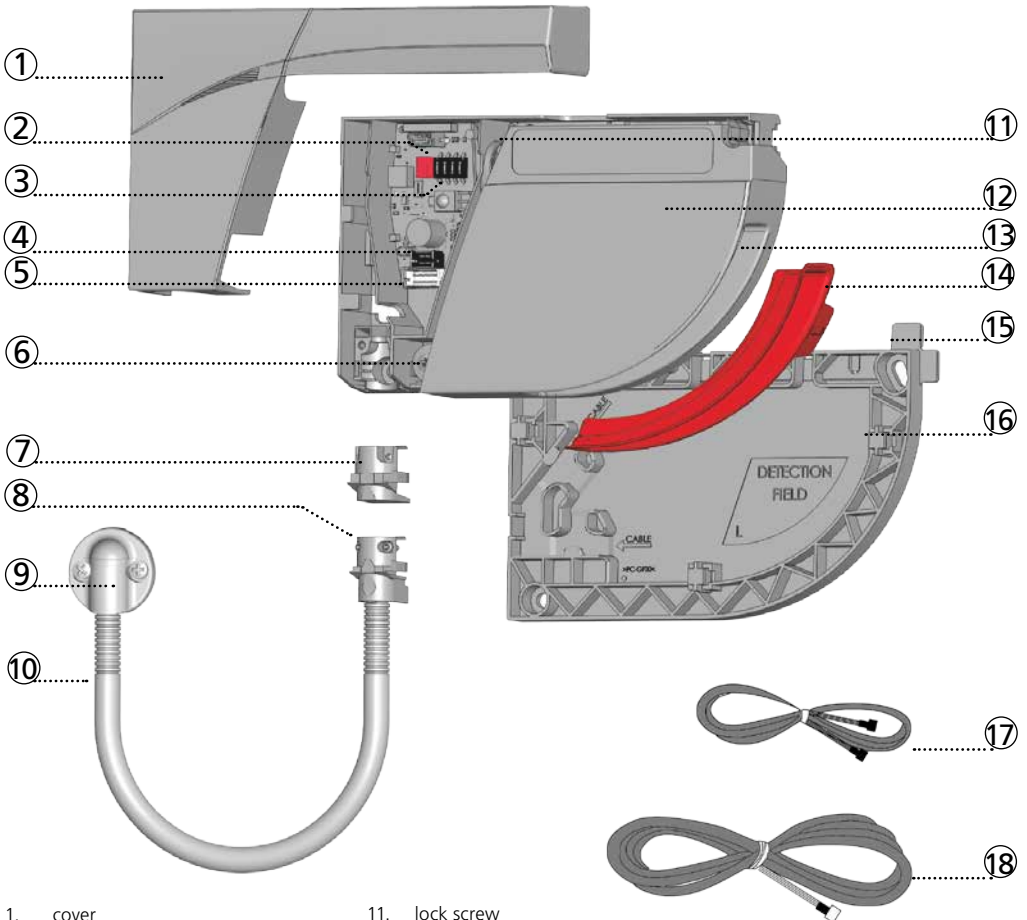

- |     |                               |     |                         |
|-----|-------------------------------|-----|-------------------------|
| 1.  | cover                         | 11. | lock screw              |
| 2.  | push button                   | 12. | laser head              |
| 3.  | DIP-switch                    | 13. | laser window            |
| 4.  | master-slave connector        | 14. | laser window protection |
| 5.  | main connector                | 15. | positioning aids        |
| 6.  | angle adjustment screw        | 16. | mounting base           |
| 7.  | plug                          | 17. | master-slave cable      |
| 8.  | clamp                         | 18. | power cable             |
| 9.  | cap and screws (flexible kit) |     |                         |
| 10. | flexible tube                 |     |                         |

## LED-SIGNALS

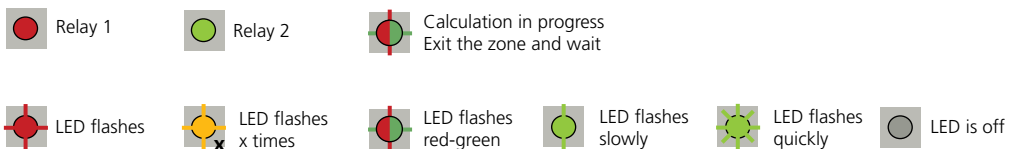

# 1 MOUNTING ON DOOR



For optimum safety, install 1 module on each door wing side and interconnect them via the master-slave cable.

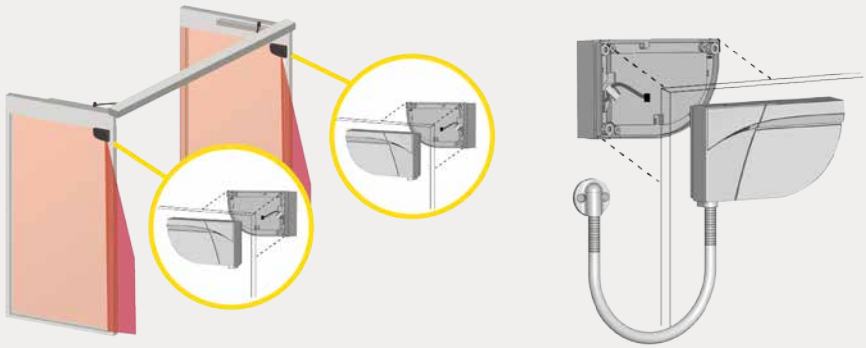

1

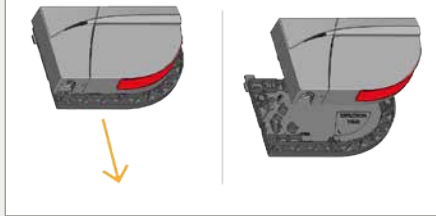

Slide the base off the sensor module.

2

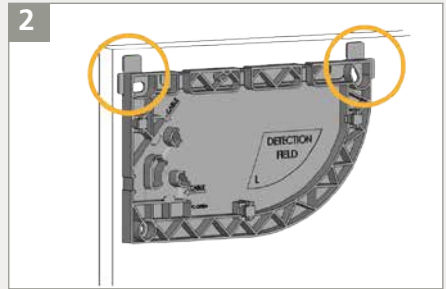

Take the base and put it on the door frame. The positioning aids help you to align the base correctly.

3

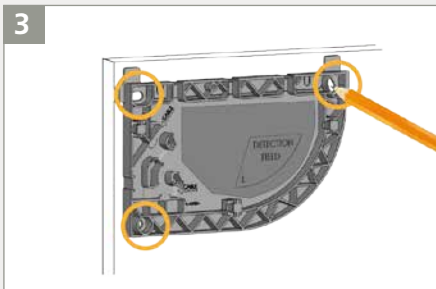

Using a pencil, mark the position of the holes to drill into the door frame. You can also use the inner surface of the base to fasten the screws.

4

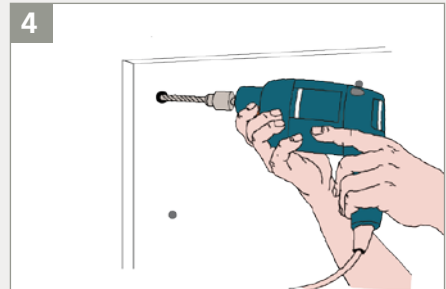

Remove the base and pre-drill the holes where marked.



When mounting the base, make sure the sensor will not hinder the door movement. If the sensor isn't correctly positioned, it could be crushed during the opening of the door.

5

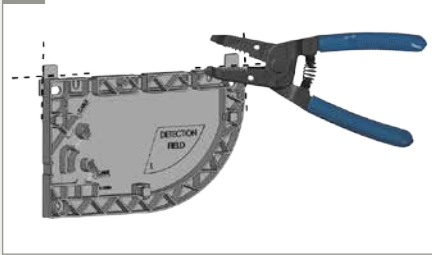

Using a wire cutter, remove the positioning aids from the base.

6

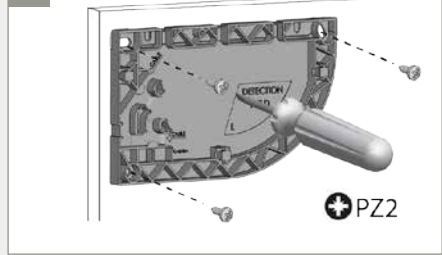

Fasten the 3 screws using a Pozidrive screwdriver. The base needs to be fixed firmly!



7

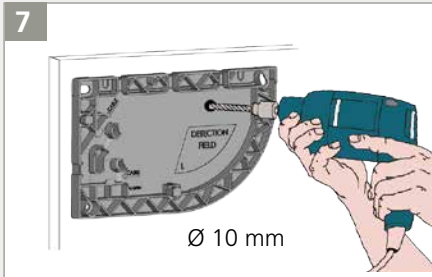

Drill through the 2 bases and the door using a 10 mm bit in order to pass the master-slave cable. Soften the edges using a sheet of sandpaper.

8

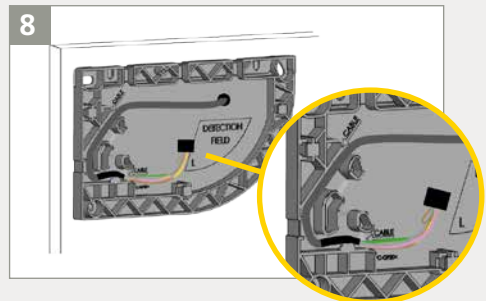

Take the master-slave cable and pass it through the hole. Position the cable in the notch of the base and make sure it is firmly fixed.

9

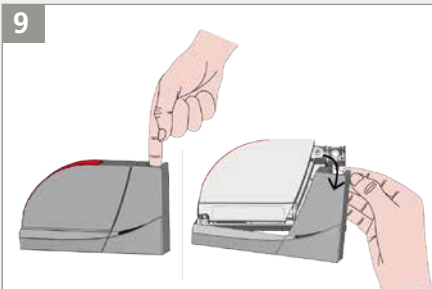

Take the sensor and remove the cover: put your finger in the hole and pull firmly towards you in one go.

10

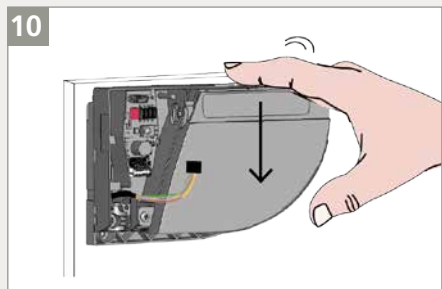

Pass the cable through the hole on the back of the sensor and fasten the sensor on the base by sliding it downwards.

11

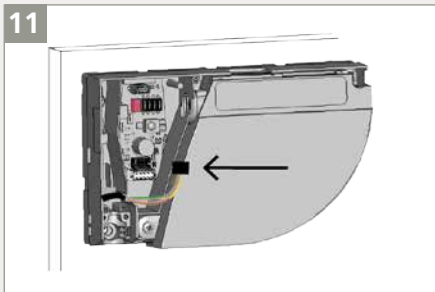

Connect the black plug to the black connector.

12

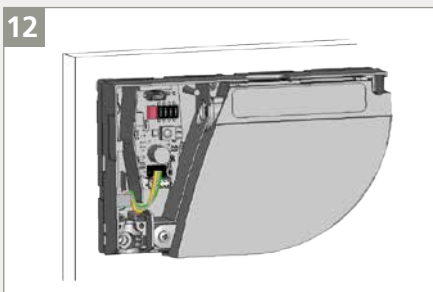

Make sure that all wires are safely tucked within the notch to avoid crushing them with the cover.

13

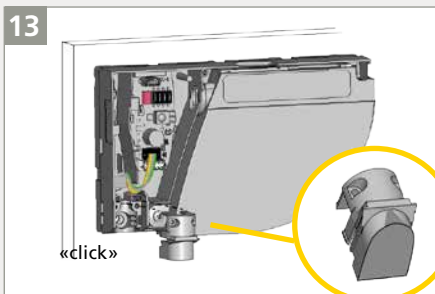

Close the sensor which will not be connected to the door controller using a plug.

Sensor connected to other module = SLAVE

14

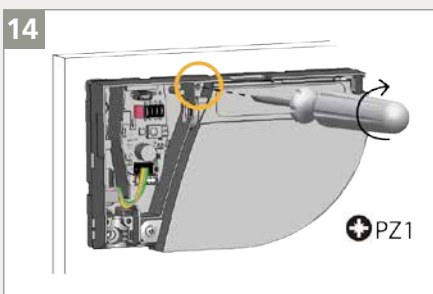

Fasten the lock screw **firmly** in order to avoid vibrations during the door movement.



## 2 WIRING TO DOOR CONTROLLER

1

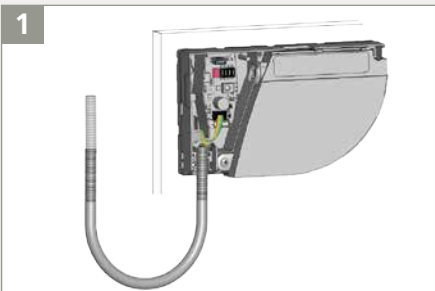

Take the flexible tube and determine how long it should be in order to reach the door controller.

2

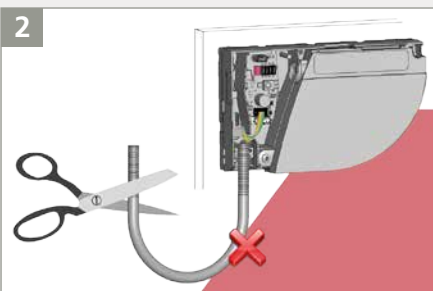

Cut the surplus to avoid undesired detections caused by the flexible tube.

3

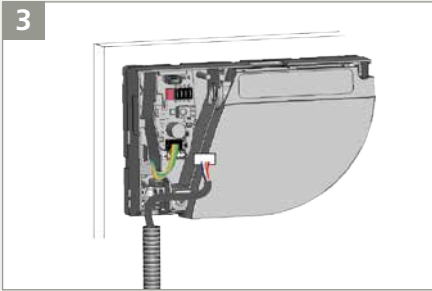

Pass the power cable through the flexible tube.  
Connect the white plug to the white connector.

**Sensor connected to door controller = MASTER**

4

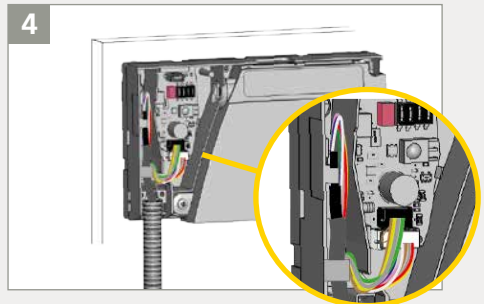

Make a loop with the wires of the power cable and pass them through the notch as indicated.  
Use the other part of the cable to block the wires.

5



Take the clamp to fix the flexible tube to the sensor.  
Fasten the 2 screws firmly in order to avoid pulling out the cable.

6

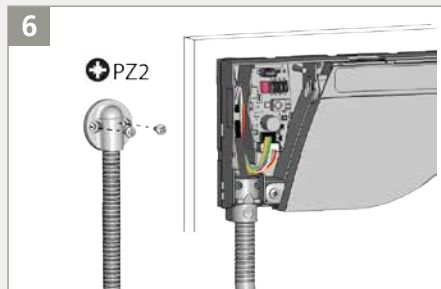

Tighten the other side of the flexible tube using the cable cap and pass through the rest of the power cable towards the door controller.

7

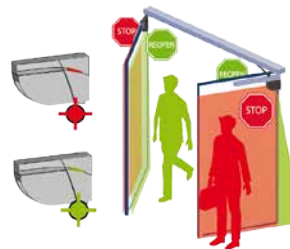
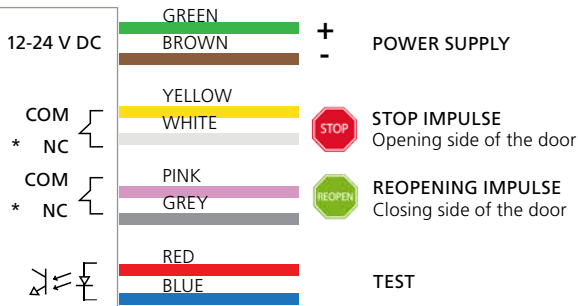

\* Output status when sensor is operational.

Cut the power cable to the right length, strip the 8 wires and connect all wires as indicated.  
The polarity of the power supply is important.

For compliance with EN 16005 and DIN 18650, the door controller test output must be connected and able to test the sensor.



### 3 DIP-SWITCH 1

Make sure the setting of DIP 1 is correct on all modules according to the door side.

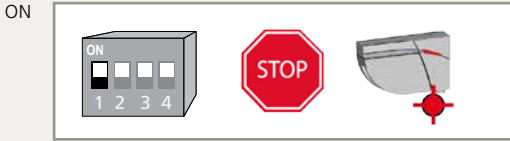

RELAY 1: STOP-impuls on the opening side of the door

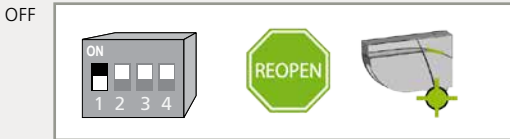

RELAY 2: REOPENING-impuls on the closing side of the door

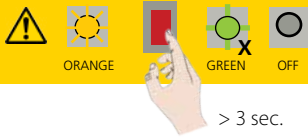
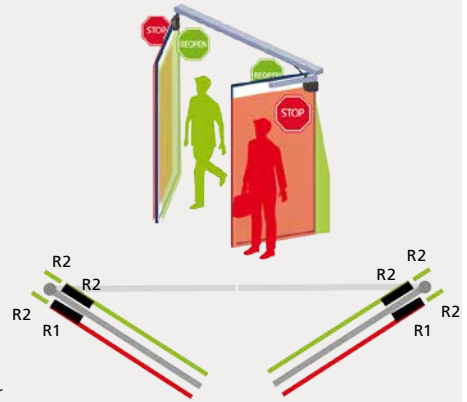

After changing a DIP-switch, the orange LED flashes. A LONG push on the push button confirms the settings. Afterwards, a number of green flashes (x) indicates the number of connected modules.

> 3 sec.

### 4 TEACH-IN



Before launching a teach-in, make sure that:

- the door is closed (use the service mode if needed, see page 9).
- both relays are connected to the door controller and the master-slave cable is connected between the modules.
- the detection field is free of snow buildups, heavy rain, snowfall, fog or other objects or people.
- the laser window protection is removed

1. To launch a teach-in, press the push button of the master\* module briefly. The LED starts to flash red-green quickly. When installing the sensor on a double swing door, repeat this on the second master module.
2. Wait until both sensors flash green. Position yourself in front of the door and stretch out your arm in front of you. Make an up and down movement at closing edge level in order to mark the limit of the detection zones. The LED flashes red while calculating the width of the door wings.
3. Wait until the sensors flash green again. Make sure you are outside of the detection field and activate a door opening so the sensors can learn the environment. During the closing of the door, the sensor flashes red.
4. Once the door is completely closed again and the LED is off, the teach-in is completed.

\* A teach-in on the master configures both the master and the slave. A teach-in on the slave only configures the slave. In case the master and slave module are not aligned, first launch a teach-in on the master and then on the slave.

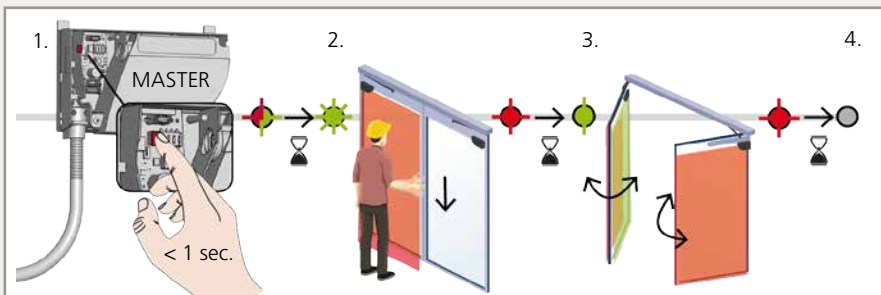



## 5 TESTING AND ADJUSTING



Check the correct positioning of the safety fields by placing an object in the detection field.

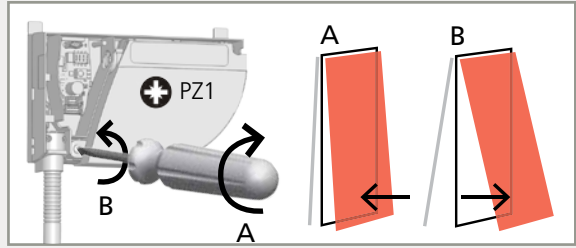

If necessary, adjust the tilt angle of the laser curtain by turning the tilt angle adjustment screw (from 2° to 10°).

**!** After changing the angle, the sensor position or the environment, always launch a teach-in and test the correct positioning of the detection fields.

## 6 FINAL STEPS

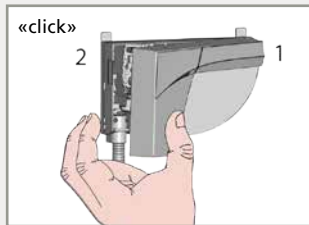

Close the cover starting on the narrow side. Do not hesitate to push.

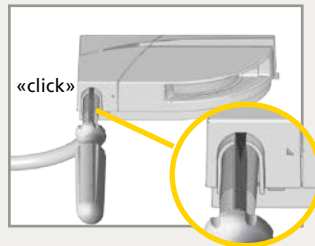

To open the sensor again, position a screwdriver in the notch and pull upwards until the cover comes loose.

Watch our FLATSCAN SW tutorial online: [bea-flatscan.com/tutorial](http://bea-flatscan.com/tutorial)



## ! SERVICE MODE

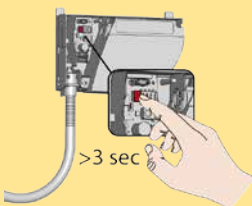

The service mode deactivates the safety detection during 15 minutes and can be useful during an installation, a mechanical teach-in of the door or maintenance work.

To enter the service mode, push on the button for at least 3 seconds. When the sensor is in service mode, the LED is off.

To exit the service mode, push again for at least 3 seconds.

The service mode is deactivated automatically when launching a teach-in.



## DIP-SWITCH SETTINGS (OPTIONAL)

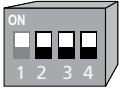

In order to change these settings by remote control, adjust the corresponding DIP-switches to ON.

	ON	OFF	
<b>DIP 2 ENVIRONMENT</b>	standard	critical*	Switch to CRITICAL when external disturbances are likely to cause unwanted detections (min. obj size, immunity and uncovered zone are increased).
<b>DIP 3 BACKGROUND</b>	on	off	Switch to OFF when there is no background (glass floor, footbridge...).
<b>DIP 4 PINCH ZONE</b>	on	off	Switch to OFF when the hinge area does not need to be secured and objects can cause unwanted detections.

\* Make a risk analysis to check if the environment requires an additional mechanical protection in the hinge area.



ORANGE



GREEN



OFF



After changing a DIP-switch, the orange LED flashes. A LONG push on the push button confirms the settings. Afterwards, a number of green flashes (x) indicates the number of connected modules.

## REMOTE CONTROL SETTINGS (OPTIONAL)

### DIMENSIONS DOOR WING SAFETY

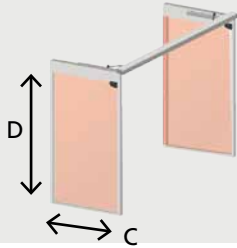

**CE** ↔ 0 0 0 0 0 1 - 4 0 0  
no field 001 - 400 cm

\* **DE** ↔ 0 0 0 0 0 1 - 4 0 0  
no field 001 - 400 cm

\* The uncovered zone (F2) is deducted from the inserted value.

A teach-in overwrites these values automatically.

### DIMENSIONS PINCH ZONE SAFETY

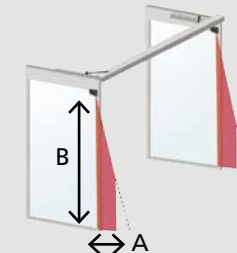

**AE** ↔ 0 0 0 0 0 1 - 1 0 0  
no field 001 - 100\*\* 040 cm

\* **BE** ↔ 0 0 0 0 0 1 - 4 0 0  
no field 001 - 400 cm

\* The uncovered zone (F2) is deducted from the inserted value.

\*\* The actual dimensions depend on the mounting height (100 cm at 4 m).

DIP 4 = ON

A teach-in overwrites these values automatically.

## OUTPUT CONFIGURATION



	1	2	3	4		NO	NC
R1	NO	NC	NC	NO	NO POWER		
R2	NC	NO	NC	NO	NO DETECTION		
					DETECTION		

NO = normally open  
NC = normally closed

## IMMUNITY FILTER

	1	2	3	4	5	6	7	8	9
	low	>	>	>	>	>	>	>	high

Increase to filter out external disturbances.

The reaction time increases significantly between value 5 and 9.

DIP 2 = ON

## UNCOVERED ZONE



F2	1	2	3	4	5	6	7	8	9	cm*
	2	4	6	8	10	12	14	16	18	

Increase in case of snow, dead leaves, etc.

\* measured in specific conditions and dependant on application and installation.

DIP 2 = ON

## ANTIMASKING & BACKGROUND

	0	1	2	3	
ANTIMASKING	OFF	OFF	ON	ON	
BACKGROUND	OFF	ON	OFF	ON	

Antimasking: protective function which detects an unwanted object nearby the laser window masking the vision field.

Background: reference point in the detection field of the sensor.

If no background is present, switch to off.

DIP 3 = ON

## GENERAL

	0	8	9
	teach-in	full reset	partial reset
	See page 8	Factory reset of all values	Factory reset of all values except field dimensions and output configurations

FACTORY VALUE

## HOW TO USE THE REMOTE CONTROL



After unlocking, the red LED flashes and the sensor can be adjusted by remote control.



If the red LED flashes quickly after unlocking, you need to enter an access code from 1 to 4 digits. If you do not know the access code, **cut and restore the power supply**. During 1 minute, you can access the sensor without introducing any access code.



To end an adjustment session, always lock the sensor.



It is recommended to use a different access code for each module in order to avoid changing settings on both modules at the same time.

### SAVING AN ACCESS CODE

The access code is recommended for sensors installed close to each other.



### DELETING AN ACCESS CODE



Enter the existing code

### ADJUSTING ONE OR MORE PARAMETERS

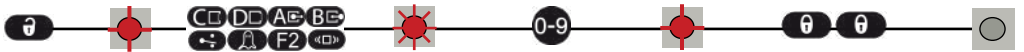

### CHECKING A VALUE



x = number of flashes = value of the parameter

= field width: 2.35 m

### RESTORING TO FACTORY VALUES

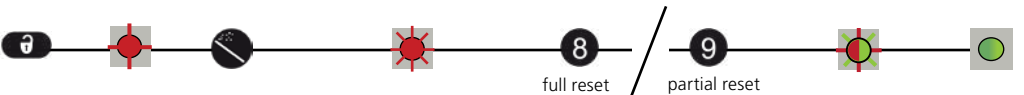

## DETECTION FIELDS

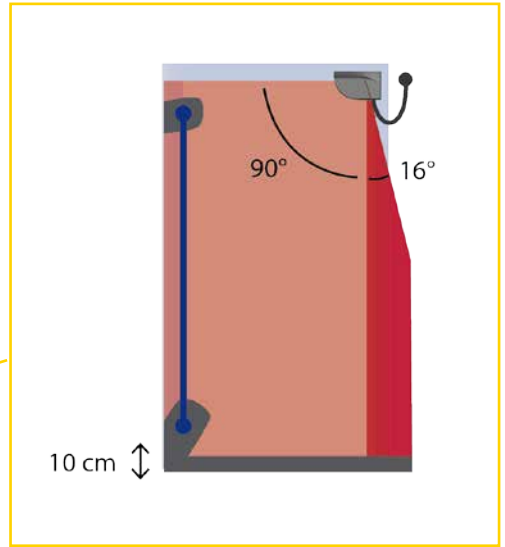
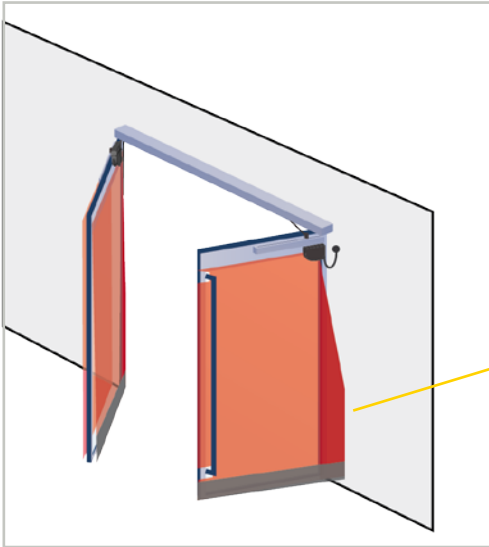

 DOOR WING SAFETY  
Typ. object size: 10 cm at 4 m

 PINCH ZONE SAFETY  
Typ. object size: 2 cm at 4 m

 UNCOVERED ZONE  
Adjustable by remote control  
factory value: 10 cm

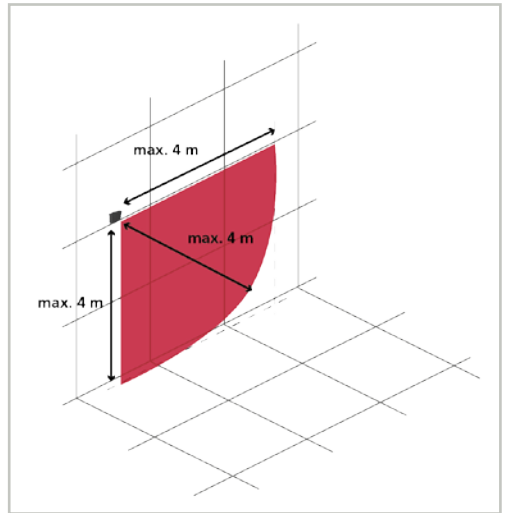
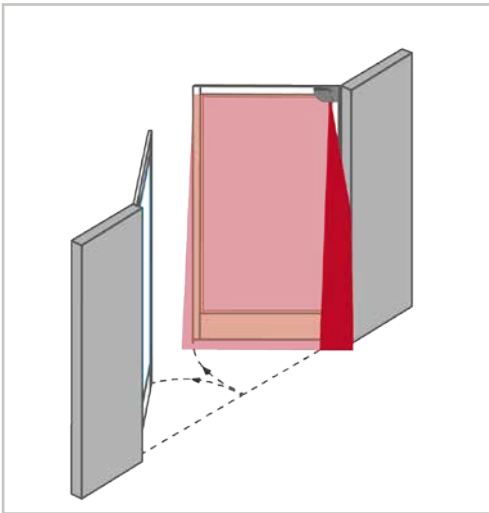



Check the detection fields using our online sizer tool:  
[bea-flatscan.com/sizer](http://bea-flatscan.com/sizer)



## TROUBLESHOOTING













In case of unwanted reactions of the door, verify whether the problem is caused by the sensor or the door controller. To do so, activate the service mode (no safety) and launch a door cycle. If the door cycle is completed successfully, check the sensor. If not, verify the door controller or wiring.

 	The RED or GREEN LED is ON sporadically or permanently and the door does not react as expected.	Bad teach-in	Launch a new teach-in (closed door).
		Unwanted detections (due to environment or external conditions)	1 Make sure the flexible cable does not cause detections.
			2 Verify if the laser window is dirty and clean it carefully with a damp and clean microfibre cloth if necessary (attention: the surface of the laser window is delicate)
			3 Launch a new teach-in (closed door).
		4 Switch DIP 2 to off (critical environment).	

	The sensor does not react at power-on.	Inverted power supply	Check wiring (green +, brown -).
		Faulty cable	Replace cable
		Faulty sensor	Replace sensor
The sensor does not react when powered.	Test error		Check tension between red and blue wires.
		The service mode is activated.	Press the push button during at least 3 seconds to exit the service mode.



It is not possible to adjust a setting by remote control.	Wrong DIP-switch position.	Adjust the required DIP-switches to ON.
The remote control does not react.	The sensor is protected by a password.	Enter the right password. If you forgot the code, cut and restore the power supply to access the sensor without entering a password during 1 minute.

	The ORANGE LED is on permanently.	The sensor encounters a memory problem.		Send the sensor back for a technical check-up.
	The ORANGE LED flashes quickly.	DIP-switch setting awaiting confirmation.		Confirm the DIP-switch setting: long push on the push button.
	The ORANGE LED flashes 1 x every 3 seconds.	The sensor signals an internal fault.		Cut and restore power supply. If orange LED flashes again, replace sensor.
	The ORANGE LED flashes 2 x every 3 seconds.	Power supply is out of limit.	1	Check power supply (tension, capacity).
			2	Reduce the cable length or change cable.
		Internal temperature is too high.		Protect the sensor from any heat source (sun, hot air...)
	The ORANGE LED flashes 3 x every 3 seconds.	Communication error between modules	1	Check wiring between master and slave modules.
			2	Check wiring between interface card and laser head.
	The ORANGE LED flashes 4 x every 3 seconds.	The sensor does not see its background.		Switch DIP 3 to off (deactivates background).
			1	Make sure the laser window is not scratched. If it is, replace sensor.
			2	Remove all masking elements (insects, spider web, flexible tube, window protection).
			3	Verify if the laser window is dirty and clean it carefully with a damp and clean microfibre cloth if necessary (attention: the surface of the laser window is delicate)
			4	Switch antimasking setting to off (attention: no conformity to DIN 18650 or EN 16005).
	The ORANGE LED flashes 5 x every 3 seconds.	Teach-in error	1	Check whether all teach-in requirements are fulfilled (see page 8) and launch a new teach-in (closed door).
			2	Adjust the tilt angle of the laser curtain and launch a new tach-in (closed door).
			3	Adjust the field dimensions by remote control. Push   and activate a door opening (step 3 of teach-in).
		Permanent faulty measurements of door position.	1	Launch a new teach-in (closed door).
			2	If orange LED flashes again, contact BEA.
	The ORANGE LED flashes 6 x every 3 seconds.	Sporadic faulty measurements of door position.	1	Clear field and wait until the door closes.
			2	If the door does not close, cut power supply and restore it once the door is fully closed.
			3	Launch a new teach-in (closed door).

## TECHNICAL SPECIFICATIONS

<b>Technology</b>	LASER scanner, time-of-flight measurement
<b>Detection mode</b>	Presence
<b>Max. detection range</b>	4 m (diagonal) with reflectivity of 2% (i.e. : at W = 1.5m -> max. H = 3.7 m)
<b>Opening angle</b>	Door wing safety: 90° / Pinch zone safety: 16°
<b>Angular resolution</b>	Door wing safety: 1.3°/ Pinch zone safety: 0.2°
<b>Typ. min. object size</b>	
Door wing safety	10 cm @ 4m (in proportion to object distance, DIP 2 = ON)
Pinch zone safety	2 cm @ 4m (in proportion to object distance, DIP 2 = ON)
<b>Testbody</b>	700 mm × 300 mm × 200 mm (testbody A according to EN 16005 & DIN 18650)
<b>Emission characteristics</b>	
IR LASER	Wavelength 905 nm; max. output pulse power 25 W; Class 1
<b>Supply voltage</b>	12 - 24 V DC ± 15 %
<b>Power consumption</b>	≤ 2 W
<b>Response time</b>	Door wing safety: max. 50 ms / Pinch zone safety: max. 90 ms
<b>Output</b>	2 electronic relays (galvanic isolation - polarity free)
Max. switching voltage	42V AC/DC
Max. switching current	100 mA
<b>LED-signals</b>	1 bi-coloured LED: detection/output status
<b>Dimensions</b>	142 mm (L) × 85 mm (H) × 23 mm (D) (mounting bracket + 7 mm)
<b>Material - Colour</b>	PC/ASA - Black - Aluminium - White
<b>Tilt angles</b>	+2° à +10° (without mounting bracket)
<b>Protection degree</b>	IP54 (EN 60529)
<b>Temperature range</b>	-30°C to +60°C if powered
<b>Humidity</b>	0-95 % non-condensing
<b>Vibrations</b>	< 2 G
<b>Min. door wing speed</b>	2°/sec
<b>Norm conformity</b>	EN 12978; EN ISO 13849-1 Pl "d"/ CAT2; IEC 60825-1; EN 60950-1; EN 61000-6-2; EN 61000-6-3; EN 62061 SIL 2; DIN 18650-1 Chapter 5.7.4 (testbody A); EN 16005 Chapter 4.6.8 (testbody A)

Specifications are subject to change without prior notice.  
All values measured in specific conditions.



BEA SA | LIEGE Science Park | ALLÉE DES NOISIETIERS 5 - 4031 ANGLEUR (BELGIUM) | T +32 4 361 65 65 | F +32 4 361 28 58 | INFO@BEA.BE | WWW.BEA-SENSORS.COM



BEA hereby declares that the LZR®-FLATSCAN SW is in conformity with the basic requirements and the other relevant provisions of the directives EMC 2014/30/EU, LVD 2014/35/EU, MD 2006/42/EC and RoHS2 2011/65/EU.  
Notified Body for EC-type inspection: 0044 - TÜV NORD CERT GmbH, Langemarkstr. 20, D-45141 Essen  
EC-type examination certificate number: 44 205 13089611  
Angleur, April 2016 Pierre Gardier, authorized representative and responsible for technical documentation  
The complete declaration of conformity is available on our website.



Only for EC countries: According to the European Guideline 2012/19/EU for Waste Electrical and Electronic Equipment (WEEE)