

# DOLCSAW1000H Reader

## USER MANUAL



- 1] Quick Start Guide
- 2] Installation and Wiring
- 3] Connection Diagram
- 4] Programming Guide



The DOLCSAW1000H is a single door multifunction standalone access controller.

## FEATURES







- Waterproof, conforms to IP66
- One relay, remote infrared programmer
- 1,000 users (998 common users + 2 panic users)
- Can be set to read EM card, HID card, or both
- Card block enrolment
- Tri-colour LED status display
- Integrated alarm & buzzer output
- Pulse mode, Toggle mode
- Can add and use 4~6 digits PIN on Infrared Remote Control
- 2 devices can be interlocked for 2 doors
- Built in light dependent resistor (LDR) for anti tamper
- Low temperature resistance(-40°F)

## SPECIFICATIONS

<b>User Capacity</b>	<b>1000</b>
Common User	998
<b>Operating Voltage</b>	<b>12~24VAC/DC</b>
Idle Current	<35mA
<b>Proximity Card Reader</b>	<b>EM&amp;HID</b>
Radio Technology	125KHz Proximity Card
Read Range	2~6 cm
<b>Wiring Connections</b>	Relay Output, Exit Button
<b>Relay</b>	<b>One (NO, NC, Common)</b>
Adjustable Relay Output Time	1~99 Seconds (5 seconds default)
Lock Output Load	2 Amp Maximum
<b>Environment</b>	<b>Meets IP66</b>
Operating Temperature	-40°C ~60°C (-40°F ~140°F)
Operating Humidity	0~98%RH
<b>Physical</b>	<b>ABS Shell</b>
Color	Black (White optional)
Dimensions	L120mm ×W48mm ×D20mm
Unit Weight	150g
Shipping Weight	220g

# 1

# Quick Start Guide

Function Description	Operation
Enter Programming Mode	 <i>Master Code</i> Default Master Code is 123456
Change the Master Code	 <i>New Master Code</i>  <i>Repeat New Master Code</i>
Add Card User	 <i>Cards can be added continuously</i>
Delete User	 <i>For card user</i>
Exit from Programming Mode	

## IN THE BOX

DOLCSAW1000H

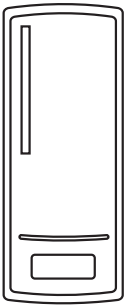

Diode IN4004 (For relay circuit protection)

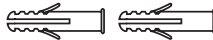

Wall Anchors



Self Tapping Screws

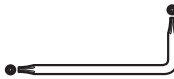

Screw Driver

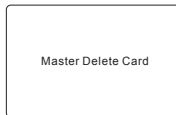
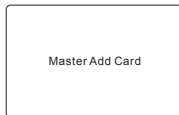

Master Cards

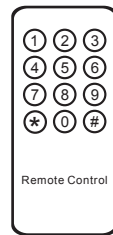

Infrared Remote Control

## 2

# Installation and Wiring

- Remove the back cover from the unit
- Drill 2 holes(A,C) on the wall for the screws and one hole for the cable
- Knock the supplied rubber bungs to the screw holes(A,C)
- Fix the back cover firmly on the wall with 4 flat head screws
- Thread the cable through the cable hole(B)
- Attach the unit to the back cover

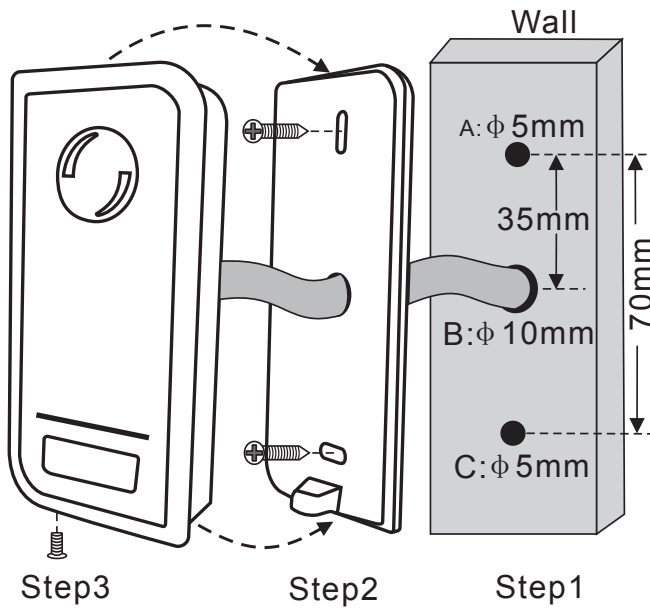

Wire Color	Function	Notes
Red	AC 1 (+DC)	12-24V AC Power Input, 12-24V DC Power Input
Black	GND	Negative Pole of DC Power Input
Pink	AC2	12-24V AC Power Input
Blue	Relay NO	Normally Open Relay Output (install diode provided)
Purple	Relay Common	Common Connection for Relay Output
Orange	Relay NC	Normally Closed Relay Output (Install diode provided)
Yellow	OPEN	Output (Install diode provided)
Advanced Input and Output Features		
Grey	Alarm Output	Negative contact for Alarm
Brown	Contact Input	Door/Gate Contact Input (Normally Closed)

## SOUND AND LIGHT INDICATION

Operation Status	LED	Buzzer
Stand by	Red light bright	----
Enter into programming mode	Red light blinks	One beep
In the programming mode	Orange light bright	One beep
Operation error	-----	Three beeps
Open lock	Green light bright	One beep
Alarm	Red light Shines quickly	Beeps

# 3

## Connection Diagram

### DC POWER SUPPLY

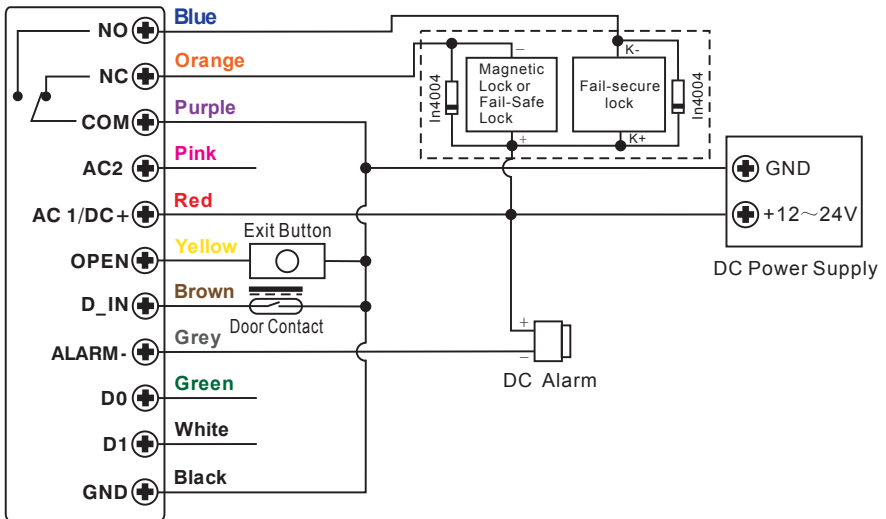

### AC POWER SUPPLY

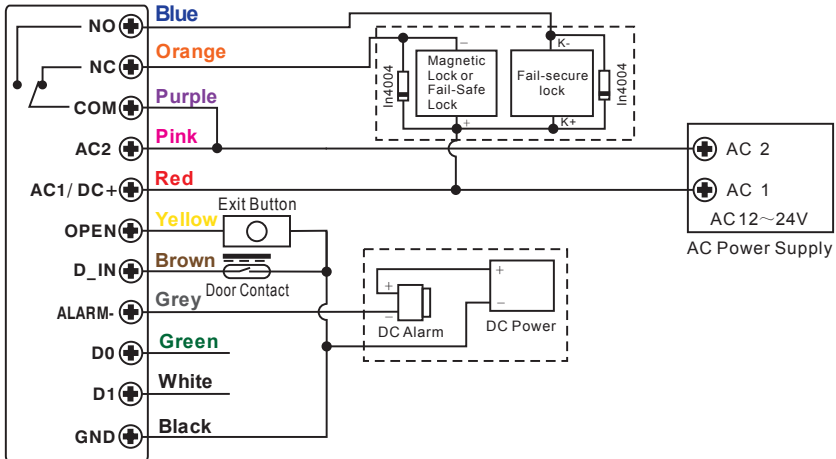

### IMPORTANT

When use AC power supply, it must be connected with the Red wire(AC1) and the Pink wire (AC2) of the reader. It is forbidden to connect the AC power to Black wire (GND), or the reader will be damaged. Install a 1N4004 or equivalent diode is needed when use a common power supply, or the reader might be damaged. (1N4004 is included in the packing).

## PROGRAMMING BY INFRARED REMOTE CONTROL

Programming will vary depending on access configuration. Follow the instructions according to your access configuration.

- User ID number: Assign a user ID to the access card in order to track it. The common user ID number can be any number from 0~997, the panic user ID is from 998~999. **IMPORTANT:** User IDs do not have to be preceded with any leading zeros. Recording of User ID is critical. Modifications to the user require the User ID be available.
- Proximity Card: Any 125KHz industry standard 26 bit EM and HID Proximity card or Tag.

## ADD COMMON USERS

Programming Step	Keystroke Combination
Enter Programming Mode	* <input type="text"/> <input type="text"/> <input type="text"/> <input type="text"/> <input type="text"/> <input type="text"/> # <i>Master Code</i>
<b>ADD CARD USER</b>	
Add Card: Using Auto ID (Allows S1/2/3/4-X to assign Card to next available User IDnumber)	1 (READ CARD) # <i>Cards can be added continuously</i>
<b>OR</b>	
Add Card: Select Specific ID (Allows Master to define a specific User ID to associate the card to)	1 <input type="text"/> <input type="text"/> <input type="text"/> # ⇒ <i>User ID*</i> (READ CARD) # <i>*User ID is any number from 0-997</i>
<b>OR</b>	
Add Card: Block Enrolment (Allows Master to add up to 998 cards to the Reader in a single step.) Takes 2 minutes to program.	1 <input type="text"/> <input type="text"/> <input type="text"/> # ⇒ <i>User ID*</i> (CARD QUANTITY) # ⇒ (FIRST CARD NUMBER) # <i>Cards' number must be consecutive; Card quantity = number of cards to be enrolled.</i>
Exit	*

## ADD PANIC USERS

Programming Step	Keystroke Combination
Enter Programming Mode	* <input type="text"/> <input type="text"/> <input type="text"/> <input type="text"/> <input type="text"/> <input type="text"/> <input type="text"/> # <i>Master Code</i>
Add Card	1 <input type="text"/> <input type="text"/> <input type="text"/> # → <i>User ID*</i> <b>(Read Card/Input 8/10 digit card number)</b> #
Exit	*

## DELETE USERS

Programming Step	Keystroke Combination
Enter Programming Mode	* <input type="text"/> <input type="text"/> <input type="text"/> <input type="text"/> <input type="text"/> <input type="text"/> <input type="text"/> # <i>Master Code</i>
<b>Delete Card User - Common</b>	
Delete Card by Card <b>OR</b> Delete Card - By ID Number <b>OR</b> Delete User - By Card Number	2 (READ CARD) # <i>Cards can be deleted continuously</i> 2 <input type="text"/> <input type="text"/> <input type="text"/> # <i>User ID</i> 2 (Input 8/10 digit card number) #
<b>Delete Panic User</b>	
Delete Panic Card User <b>OR</b> Delete Panic PIN User	2 <input type="text"/> <input type="text"/> <input type="text"/> # <i>User ID*</i> 2 <input type="text"/> <input type="text"/> <input type="text"/> # <i>User ID*</i>
<b>Delete All Users</b>	
Delete All User	2 <input type="text"/> <input type="text"/> <input type="text"/> <input type="text"/> <input type="text"/> <input type="text"/> <input type="text"/> # <i>Master Code</i>
Exit	*



## SET RELAY CONFIGURATION

Programming Step	Keystroke Combination
Enter Programming Mode	* [ ] [ ] [ ] [ ] [ ] [ ] [ ] # <i>Master Code</i>
Pulse Mode <b>OR</b> Toggle Mode	3 [ ] [ ] # <i>Relay Time*</i> <i>*1-99 seconds. Default is 5 seconds.</i> 3 0 # <i>Sets the relay to ON/OFF toggle mode</i>
Exit	*

## SET STRIKE-OUT ALARM

The strike-out alarm will engage after 10 failed card attempts (Factory is OFF). It can be set to deny access for 10 minutes after engaging or disengage only after entering a valid card/PIN or Master code.

Programming Step	Keystroke Combination
Enter Programming Mode	* [ ] [ ] [ ] [ ] [ ] [ ] [ ] # <i>Master Code</i>
Strike-Out OFF <b>OR</b> Strike-Out ON <b>OR</b> Strike-Out ON (alarm) Set alarm time	6 0 # <i>(factory default)</i> 6 1 # <i>Access will be denied for 10 minutes</i> 6 2 # 5 [ ] [ ] # <i>Alarm Time: 0-30</i> <i>Default is 1 minute. Enter Master code # or valid user card/PIN to silence</i>
Exit	*

## SET CARD READING TYPE

Programming Step	Keystroke Combination
Enter Programming Mode	* [ ] [ ] [ ] [ ] [ ] [ ] [ ] # <i>Master Code</i>
Read EM & HID® card	9 3 # <i>(factory default)</i>
<b>OR</b> Read EM card only	9 4 #
<b>OR</b> Read HID® card only	9 5 #
Exit	*

## MASTER CARD USAGE

Using Master Card to add and delete card users	
Add a Card User	<ol style="list-style-type: none"> <li>1. (Read Master Add Card)</li> <li>2. (Read User Card) <i>Repeat Step 2 for additional user cards</i></li> <li>3. (Read Master Add Card)</li> </ol>
Delete a Card User	<ol style="list-style-type: none"> <li>1. (Read Master Delete Card)</li> <li>2. (Read User Card) <i>Repeat Step 2 for additional user cards</i></li> <li>3. (Read Master Delete Card)</li> </ol>

### NOTE:

- If no Master Cards added, must press the Exit Button for at least 10 seconds before release
- Reset to Factory default, the user's information is still retained.

**TO RESET TO FACTORY DEFAULT:** Power off, press the Exit Button, hold it and power on, there will be two beeps, and the LED light turns into orange, release the exit button, then read any two 125KHz EM card or HID card, the LED will turn into red, means reset to Factory default successfully. Of the two cards reading, the 1st one is Master Add Card, the 2nd one is the Master Delete Card.

## TRANSMITTER SOLUTIONS WARRANTY

The warranty period of Transmitter Solutions keypad is twenty-four (24) months. This warranty shall begin on the date the keypad is manufactured. During the warranty period, the product will be repaired or replaced (at the sole discretion of Transmitter Solutions) if the product does not operate correctly due to a defective component. This warranty does not extend to (a) the keypad case, which can be damaged by conditions outside the control of Transmitter Solutions, or (b) battery life of the keypad. This warranty is further limited by the following disclaimer of warranty and liability:

EXCEPT AS SET FORTH ABOVE, TRANSMITTER SOLUTIONS MAKES NO WARRANTIES REGARDING THE GOODS, EXPRESS OR IMPLIED, INCLUDING WARRANTY OF MERCHANTABILITY OR WARRANTY OF FITNESS FOR A PARTICULAR PURPOSE. BUYER MAKES NO RELIANCE ON ANY REPRESENTATION OF TRANSMITTER SOLUTIONS, EXPRESS OR IMPLIED, WITH REGARD TO THE GOODS AND ACCEPTS THEM "AS-IS/WHERE-IS". TRANSMITTER SOLUTIONS SELLS THE GOODS TO BUYER ON CONDITION THAT TRANSMITTER SOLUTIONS WILL HAVE NO LIABILITY OF ANY KIND AS A RESULT OF THE SALE. BUYER AGREES THAT TRANSMITTER SOLUTIONS SHALL HAVE NO LIABILITY FOR DAMAGES OF ANY KIND, WHETHER DIRECT, INCIDENTAL OR CONSEQUENTIAL DAMAGES, INCLUDING INJURIES TO PERSONS OR PROPERTY, TO BUYER, ITS EMPLOYEES OR AGENTS, AS A RESULT OF THE SALE. BUYER ALSO AGREES TO HOLD TRANSMITTER SOLUTIONS HARMLESS FROM ANY CLAIMS BUYER, OR ANY THIRD PARTY, MAY HAVE AS A RESULT OF BUYER'S USE OR DISPOSAL OF THE GOODS. BUYER HAS READ THIS DISCLAIMER AND AGREES WITH ITS TERMS IN CONSIDERATION OF RECEIVING THE GOODS.



3850 West 2480 South, Suite B  
Salt Lake City, UT 84120  
(866) 975-0101 • (866) 975-0404 fax  
[www.transmittersolutions.com](http://www.transmittersolutions.com)