

TOP, BOTTOM AND SIDE SEALS

PARTS



TODCO[®]



TOP, BOTTOM & SIDE SEAL OPTIONS

TOP PANEL & HEADER MOUNTED SEALS

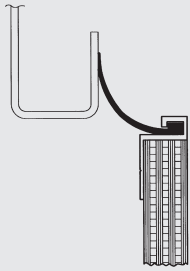

Panel Mounted – Rubber
#70001

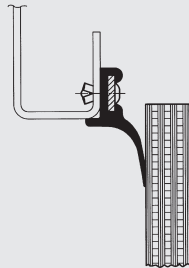

Header Mounted – Rubber
#69770

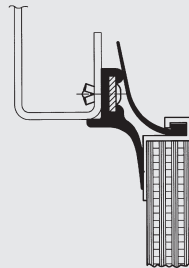

Dual Assembly – Rubber
#69770 Header Mounted
#70001 Panel Mounted

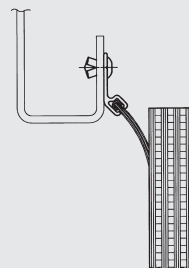

Brush Header Mounted
#70231 1" Brush
#70272 1-1/2" Brush

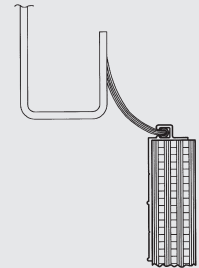

Brush Panel Mounted
#70279

DRYFREIGHT – Standard, Plywood, Dual Tite™ and Aluminum-Clad

BOTTOM PANEL SEALS

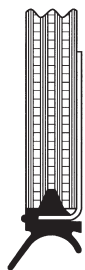

Standard – Rubber
#80840

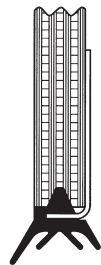

Optional – Rubber
#89204

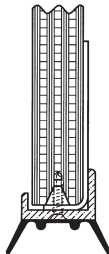

Replaceable - Vinyl
(original)
#70337

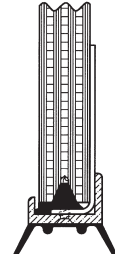

Replaceable - Vinyl
(replacement)
#70337

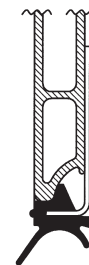

Rubber
#80840

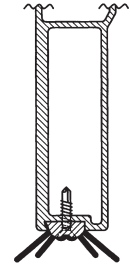

Rubber
#70354

DRYFREIGHT – Standard, Plywood, Dual Tite and Aluminum-Clad

WEATHERTITE

FLEETSTAR

SIDE SEALS AND SECONDARY SEALS

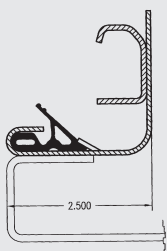

Standard – Rubber
#61390

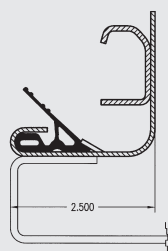

Long Lip – Rubber
#69840

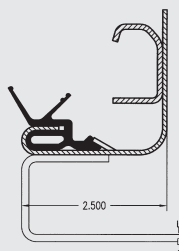

Dual Lip – Rubber
#70131

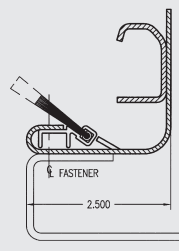

Brush Assembly
1" Brush #70232
1-1/2" Brush #70313

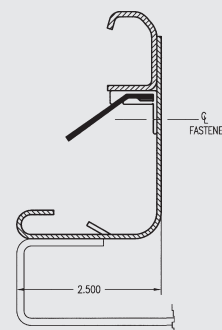

End Seal Assembly
Belted Material #70118

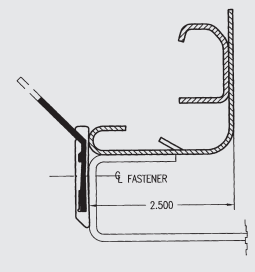

Secondary Seal Assembly
Belted Material #70105
(Long Lip #70142)

Installations with Standard 2-1/2" Sideroom Mounting Angle/Track Spacing

TOP PANEL & HEADER MOUNTED SEALS (cont'd)

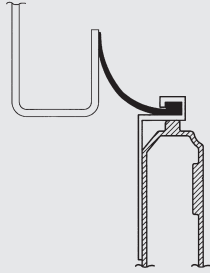

Panel Mounted – Rubber
#70289

FLEETSTAR®

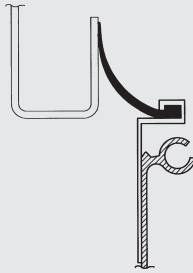

Panel Mounted – Rubber
#70289

CITYCARGO™

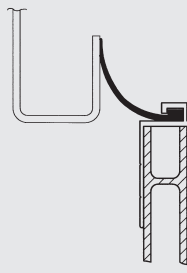

Panel Mounted – Rubber
#70468

WEATHERTITE™

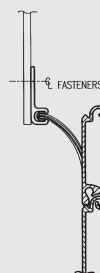

Header Mounted – 1" Brush
#70246

ROLL-UP SHUTTER DOOR

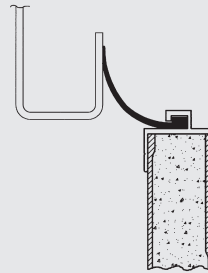

Panel Mounted – Rubber
Seal Retainer – #70083
Seal – # 69718

1- 1/8" POLARGUARD®

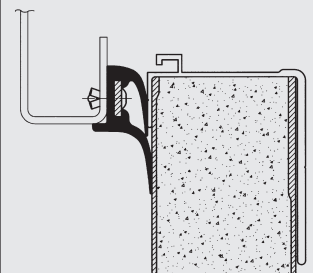

Header Mounted – Rubber
#70135

2-1/2" POLARGUARD®

BOTTOM PANEL SEALS (cont'd)

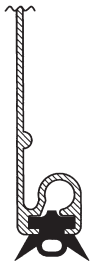

Rubber
#69242

CITYCARGO

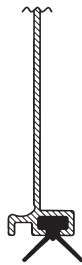

Rubber
#39218

ROLL-UP SHUTTER DOOR

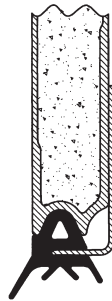

1-1/8" Door – Rubber
#70084

1-1/8" POLARGUARD

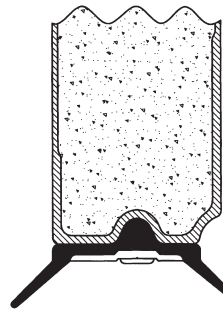

2-1/2" Door – Rubber
#69987
(Retainer #69988)

2-1/2" POLARGUARD

See back for seal measuring, ordering and installation instructions.

SIDE SEALS AND SECONDARY SEALS (cont'd)

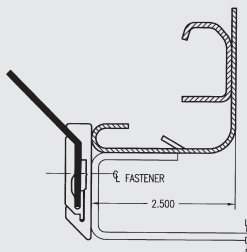

Secondary Seal Assembly
Belted Material – Removable
#70336

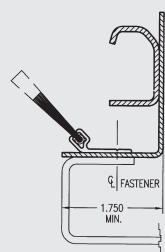

Brush Assembly
1" Brush #70231
1-1/2" Brush #70272

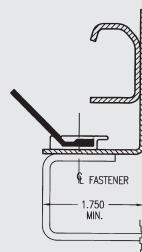

Seal Assembly
Belted Material #69922
(Long Lip #70362)

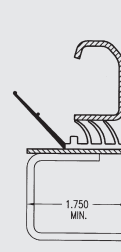

Push-In-Seal
Vinyl (1/2" Track Spacing) #70338
For 3/4" dryfreight only with standard end bing.

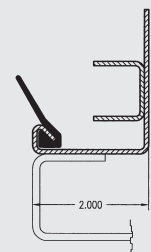

Side Seal
#39235

For less than 2-1/2" Sideroom Mounting Angle

ROLL-UP SHUTTER DOOR



TOP, BOTTOM & SIDE SEAL OPTIONS

ORDERING INSTRUCTIONS

When ordering parts, be sure to include the part name and number and your door's SERIAL NUMBER. See metal tag attached to the inside upper right-hand corner of the door (standing inside unit facing the door).



Orders for replacement door panels should specify whether top, intermediate or bottom panel is required (panel width, height and thickness dimensions should be indicated).

HOW TO MEASURE DOOR HEIGHTS

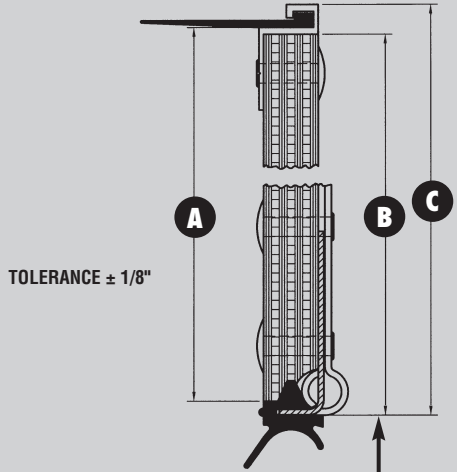

"A"= PANEL STACK-UP PLUS 1/8"
 "B"= PANEL STACK-UP PLUS 3/16"
 "C"= PANEL STACK-UP PLUS 5/8"

BOTTOM OF BOTTOM ANGLE

BOTTOM SEAL NOTCHING DETAILS

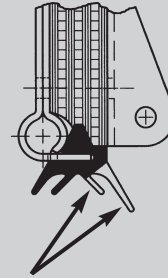
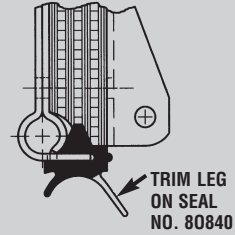

TRIM BOTH FRONT LEGS ON SEAL NO. 89204

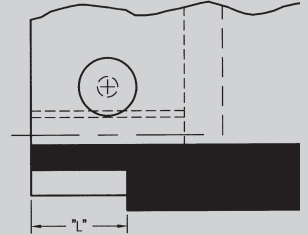

Length	Side Seal	Side Room
1-1/4"	61390	----
1-5/8"	69840	----
3/4"	70338	----
1-5/8"	69922	2" *
1-1/4"	70077	1-1/2" *
1-1/4"	70120	1-1/2" *
1-5/8"	70131	----
1-5/8"	70145	2" *
1-5/8"	70231	2" *
1-1/4"	70232	----
3/4"	XM-3186	1-5/16" *

* SEAL NOTCH LENGTH PER CHART OR ADJUST AS REQUIRED BASED ON SIDEROOMS SHOWN

SEAL INSTALLATION

Header Seal:

Cut the header seal to length to fit in between the vertical mounting angles.

Place the header seal assembly against the inside face of the header. With the small tab against the underside of the header, drill 3/16" holes and secure with drive rivets.

The 2-1/2" insulated door has a dual-lip head seal mounted in the same manner. The 1-1/8" door head seal is attached to the top panel, which is also optional on the 3/4" door.

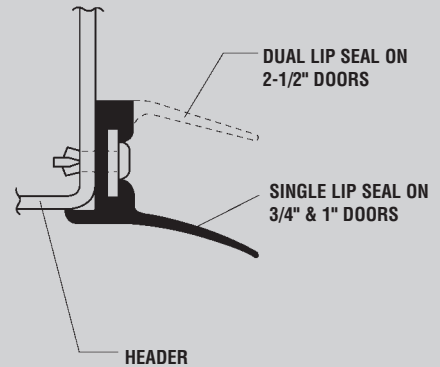

For new orders and order inquiries:

call: (740) 383-6376

fax: 1-800-24-TODCO
 (800-248-6326)

Side Seals:

Side seals are extruded in pairs. Separate the two seals along tear line. With the door raised, insert seal in retaining lip the full length of the angle.

Insert seal at bottom lance and install drive rivet in lower hole. Stretch seal 1", insert in top lance and install drive rivet in upper hole. Snap seal into all remaining lances. Trim off excess seal.

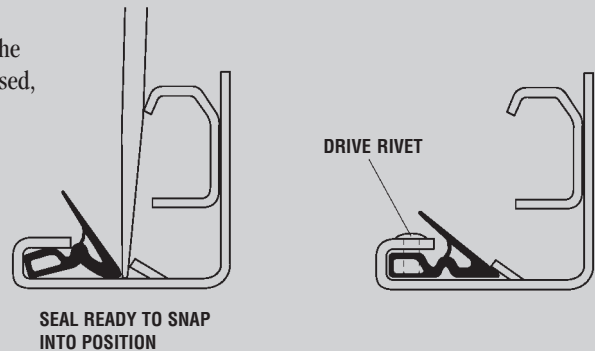

NOT JUST TOUGH...TODCO-TOUGH