



1 Unpack box and make sure you have all items shown here. (Screwdriver not shown.)

Edge Unit
(HID version shown)

12-V AC/DC Adapter
(PS-12DC1)

Key

Carriage Bolt
(4x)

Hex Nut
(4x)

2 Unlock and open front panel of unit for mounting, wiring, and setup.

3 Mount unit to pedestal using included mounting hardware. (This step may be completed later.)

WARNING

AUTOMATIC GATES CAN CAUSE SERIOUS INJURY OR DEATH!

ALWAYS CHECK THAT THE GATE PATH IS CLEAR BEFORE OPERATING!

REVERSING OR OTHER SAFETY DEVICES SHOULD ALWAYS BE USED!

CAUTION

Use all four carriage bolts when mounting the unit to a pedestal.

Leave the antenna in place.

Seal all openings created in the enclosure.

Failure to follow these instructions can damage the unit and/or cause it not to function correctly!



What's what?

All important components labeled

Unit shown with front panel open.
Wiring/cabling not shown for clarity.

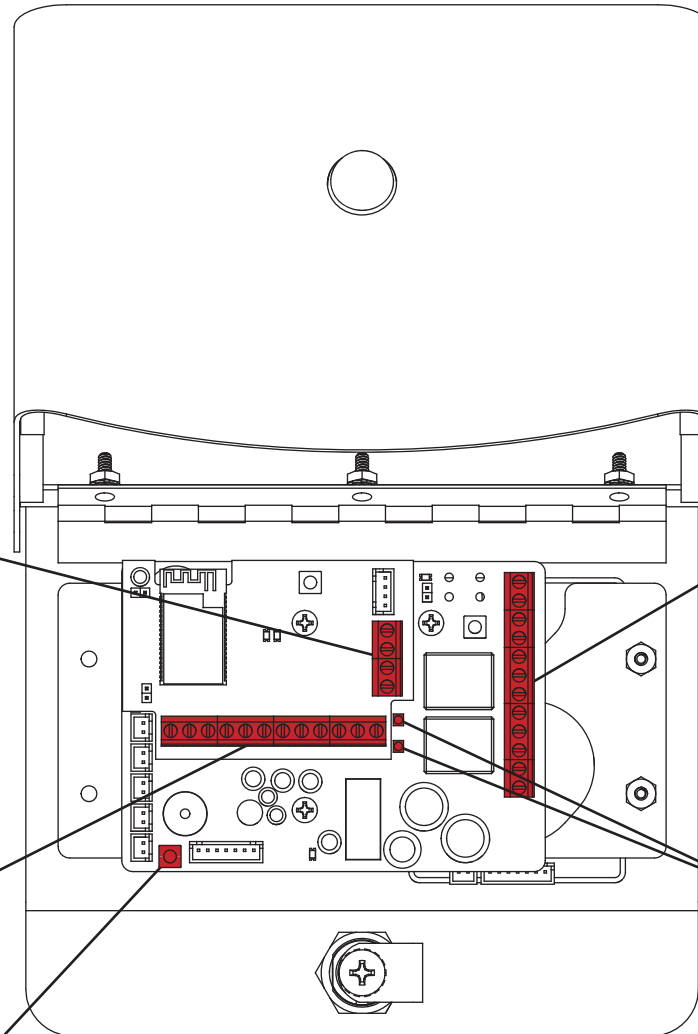

Digital Input Terminals
For connecting various accessories
See Page 5

Wiegand Terminals
For wiring to Wiegand devices
See Page 6

Reset Button
For performing unit reset

Power, Relay, Event Terminals
For wiring to power, wiring to gate operator or door opener, and connecting request-to-exit devices
See Pages 3 and 5

Relay Status LEDs
Relay is active when lit

4

Connect wires.

Feed wires through back of unit, and connect as shown using included screwdriver.

Excessive force can damage unit!

Additional wiring diagrams can be found on **Pages 5 and 6.**

CAUTION

If the included 12-V AC/DC adapter will not be used, please go to **Page 4** and follow the procedure, **Using a Third-Party Power Source.**

Do not exceed 24 VAC/DC! Failure to choose a compatible power source can damage the unit!

Edge Power, Relay, Event Terminals

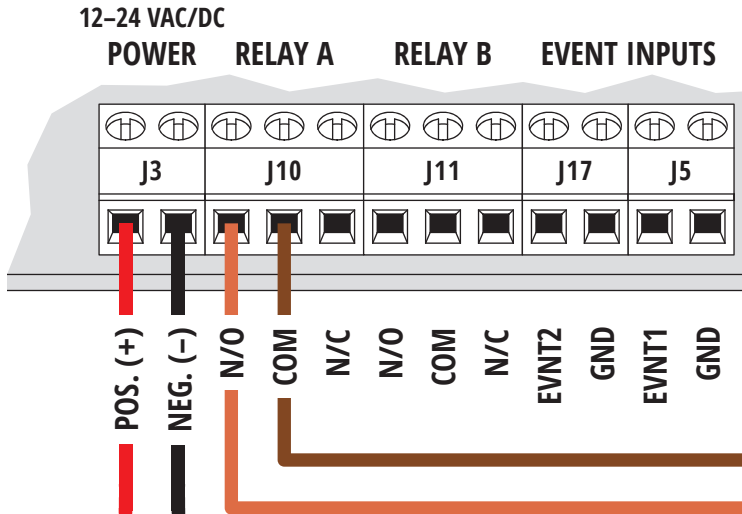

Gate Operator / Door Opener

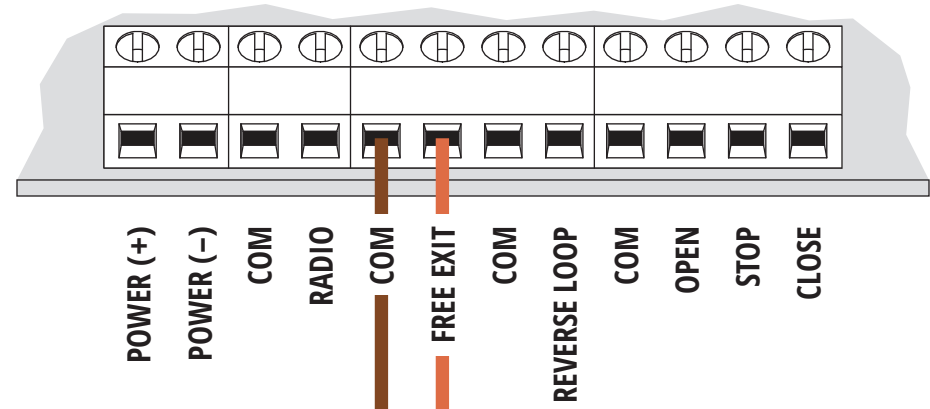

Relay B can be wired to a second device in the same manner.

Third-Party 12-24-VAC/DC Power Source

OR

The GROUND terminal is optional unless required by local code(s). If using, please connect to earth ground or equivalent.

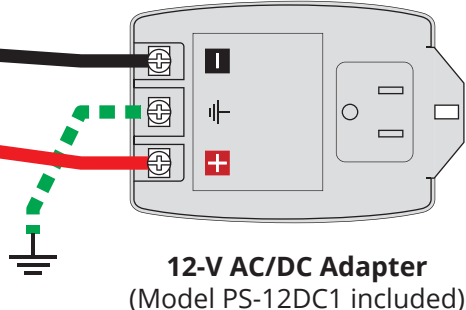

Consult gate/door opener manual for exact connections. Terminals vary widely across manufacturers and models.

If plugging into duplex outlet, remove screw from outlet plate, and secure with included screw.

Using a Third-Party Power Source (Optional)

IMPORTANT

If you would like to use a third-party power source such as solar, verify that it conforms to the following specs:

Input	12-24 VAC/DC no more than 10% beyond this range
Current Draw	less than 111 mA @ 12 VDC less than 60 mA @ 24 VDC

4a

Connect wires to unit as shown in Step 4.

4b

Connect wires to your power source, making sure you connect positive to positive and negative to negative.

CAUTION

Double check that you have wired from positive on the Edge unit to positive on your power source and negative on the Edge unit to negative on your power source.

Reverse polarity can damage the unit!

5

Close front panel of unit and lock it.

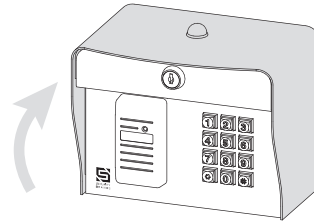

STOP

Before going forward, double check all wiring and make sure the unit has power!

Wiring diagrams for connecting to accessory devices can be found on **Pages 5 and 6**.

For connecting accessories not mentioned, please contact **Technical Support**.

Make sure the gate or door path is clear before completing Step 7!

6

Add Access Code to Relay A.

(To add multiple codes, enter each of them before pressing pound key.)

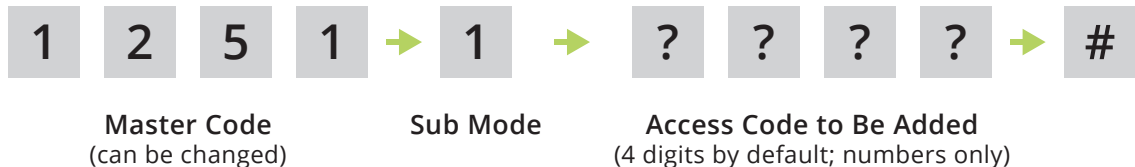

NOTE: The green arrow indicates a “good” tone on the Edge unit. By default, the following codes are reserved and cannot be used: 1251, 1273, 1366, 1381, 1387, 1678, 1752, and 1985.

7

Make sure gate or door path is clear; then enter access code on keypad, and confirm gate or door opens.



INSTALLATION COMPLETE!

Jump to **Page 7** to continue programming and download the Edge Smart Keypad app.

A Event Inputs

Wiring for accessories such as a request-to-exit device

Edge Power, Relay, Event Terminals

12-24 VAC/DC

POWER RELAY A RELAY B EVENT INPUTS

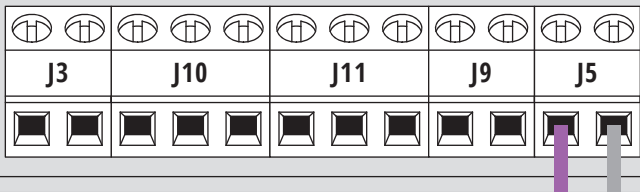

POS. (+)
NEG. (-)
N/O
COM
N/C
N/O
COM
N/C
EVENT2
GND
EVENT1
GND

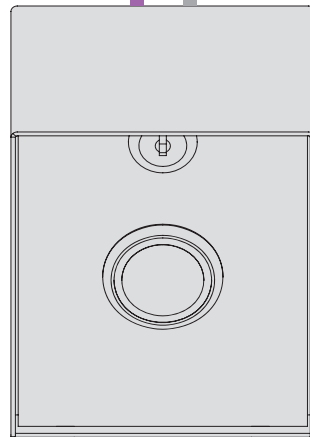

Request-to-Exit Device
(58-RTE-P is shown)

Event Input configuration instructions can be found on **Pages 10 and 11**.

B Digital Inputs

Wiring to various accessories

Edge Digital Input Terminals

DIGITAL INPUTS

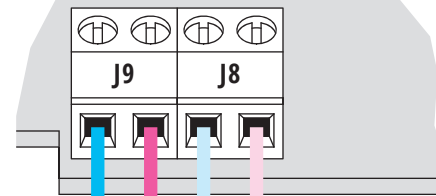

#1
GND
#2
GND

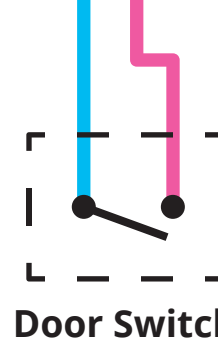

Door Switch

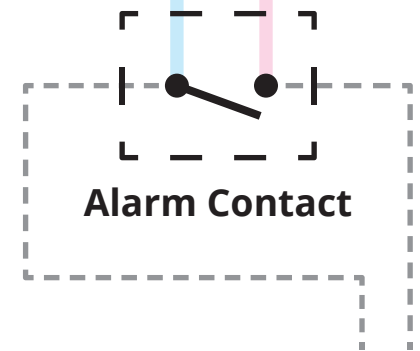

Alarm Contact

To Alarm System

Digital Inputs can be configured using the Edge Smart Keypad app.

C

Wiegand Device

Wiring for a Wiegand device

Wiegand programming instructions can be found starting on **Page 14**.

⚠ CAUTION ⚠

Disconnect power to the Edge unit before connecting Wiegand devices.

Failure to disconnect power can damage the unit!

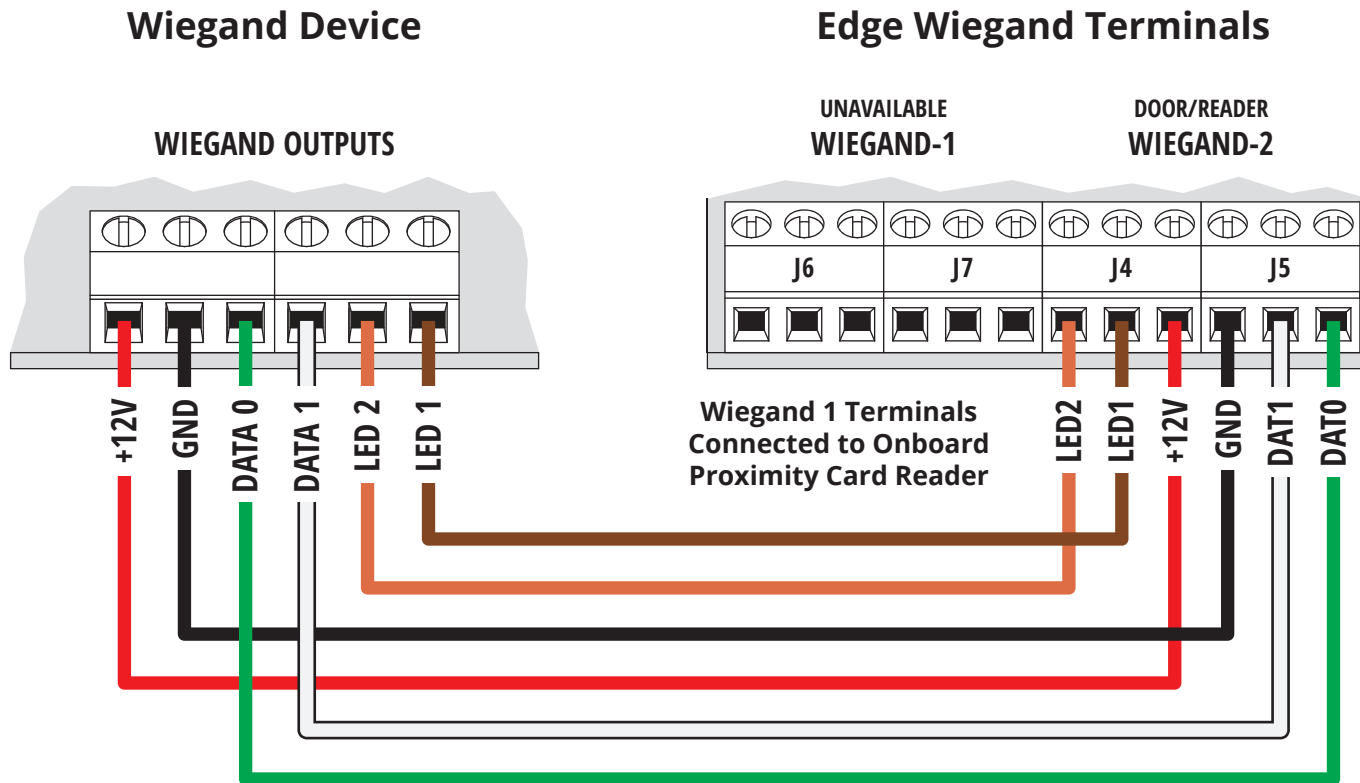

Downloading the Edge Smart Keypad App for iOS/Android



The Edge Smart Keypad app is for **ADMINISTRATOR USE ONLY** and is not intended for users.

a

Grab your smartphone or tablet. (These steps are optional. Unit can be fully programmed from keypad.)

b

Navigate to your app store, and search for "edge smart keypad."

c

Find the Edge Smart Keypad app by Security Brands, Inc. and download it.



Edge Smart Keypad
Security Brands, Inc.



NEED HELP



You can find plenty of useful resources online to help you get your new Edge unit up and running quickly and easily.

Go to securitybrandsinc.com/edge/

If you need further assistance, please call Technical Support at **(972) 474-6390**.

D

Pairing Edge Unit

Connecting your mobile device to your Edge unit for use with app.

The app is available for administrators who want to use it. Nearly all functionality is available through direct programming via the keypad.

ⓘ IMPORTANT! Make sure your Edge unit is powered on and that Bluetooth is enabled on your mobile device or pairing will not work.

Step 1 - Grab your mobile device and open the Edge Smart Keypad app.

If you do not have the app, follow the steps on this page for downloading it.

Step 2 - Fill out your account information and tap the "Sign Up" button.

If you have already created an account, you will log in instead.

Step 3 - On the Paired Keypads screen, tap the "Add Keypad" button.

Step 4 - On the Add Keypad screen, tap the Edge unit you want to pair.

If you do not see any Edge units listed, make sure your Edge unit is powered on and is in Bluetooth range.

Step 5 - Complete the procedure shown on your mobile device.

These steps will be completed using the PIN pad on your Edge unit.

Step 6 - Enter the Master Code (default is 1251) on your mobile device.

Step 7 - Enter the code shown on your mobile device at the Edge unit.

This step must be completed within the time duration displayed.

Step 8 - Change your Master Code if you like.

This step is recommended, but optional, and can be done at a later time.

Your new Edge unit is now be paired and will appear on the Paired Keypads screen. Tapping on the Edge unit on this screen will give you access to relay control and full access control management of the Edge unit from within the app.



For more information and guidance, please go to securitybrandsinc.com/edge/ or call Technical Support at **(972) 474-6390** for assistance.

E1 Direct Programming / Unit Configuration

Change Master Code

(Highly recommended for security purposes)



Current Master Code
(1251 is default)

Sub Mode

New Master Code
(4 digits; numbers only)

Change Sleep Code



Master Code
(1251 is default)

Sub Mode A

Sub Mode B

Sleep Code
(4 digits; numbers only)

Green arrow indicates “good” tone on unit. Always wait for good tone before moving on.

By default, these codes are unavailable for use: 1251, 1273, 1366, 1381, 1387, 1678, 1752, 1985.



FIND MORE



For all programming not shown here, as well as reset procedures and the Edge Smart Keypad app user guide, please visit our Edge start page:

securitybrandsinc.com/edge/

Programming Sub Modes

- | | | | |
|-------|----------------------------------|-------|--|
| 1 | Add Access Code(s) to Relay A | 4 - 7 | Enable/Disable Timers and Schedules |
| 2 | Delete Code (Non-Wiegand) | 4 - 8 | Enable/Disable “3 Strikes, You’re Out” |
| 3 | Change Master Code | 4 - 9 | Configure Event Input 1 |
| 4 - 3 | Add Latch Code to Relay B | 5 | Add Latch Code to Relay A |
| 4 - 4 | Change Sleep Code | 6 | Configure Wiegand Inputs |
| 4 - 5 | Change Code Length (Non-Wiegand) | 7 | Add Access Code(s) to Relay B |
| 4 - 6 | Change Relay Trigger Time | 8 | Add Limited-Use Code |
| | | 0 | Delete All Codes and Timers |

Things to Know

The Star Key (*)

If a mistake is made, pressing the star key deletes your entry. Two beeps will sound.

The Pound Key (#)

The pound key is good for one thing and one thing only: exiting programming mode.

E2 Direct Programming / Unit Configuration

Green arrow indicates "good" tone on unit.
Always wait for good tone before moving on.

Change Code Length

⚠ IMPORTANT! THIS WILL DELETE ALL NON-WIEGAND ACCESS AND LATCH CODES!

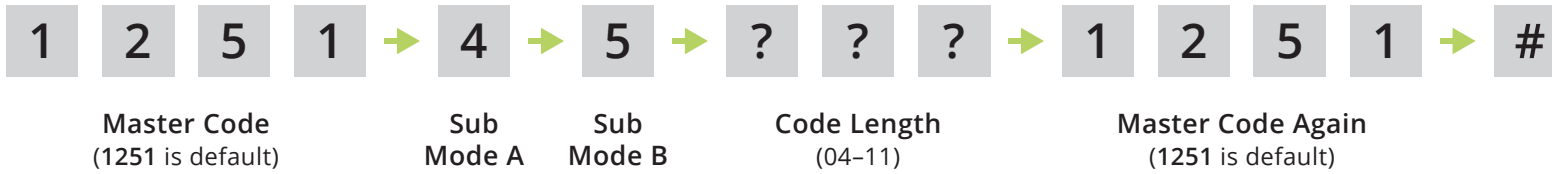

Change Relay Trigger Time

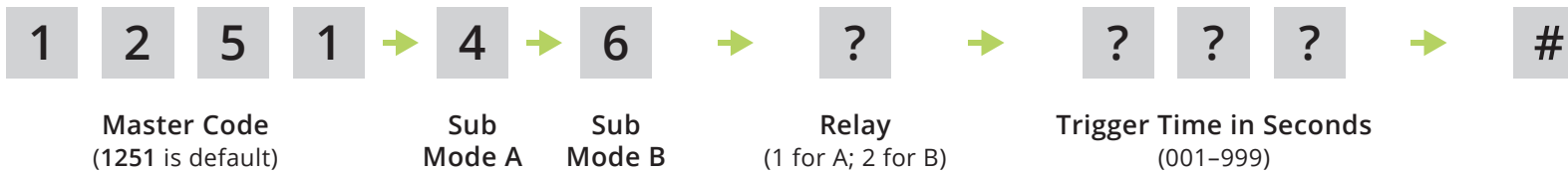

Enable/Disable Timers and Schedules

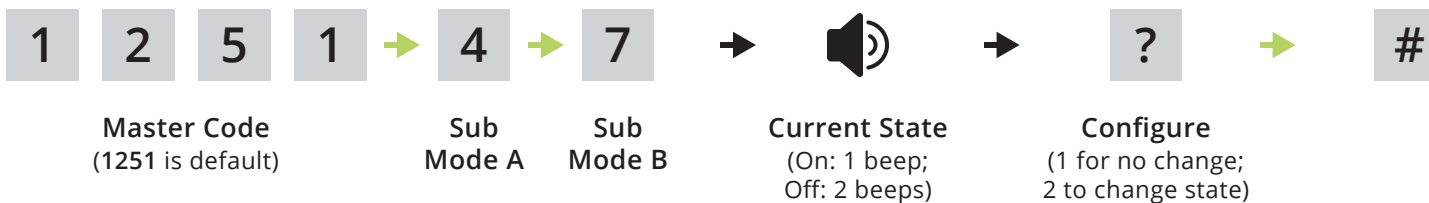

Enable/Disable "3 Strikes, You're Out"

(When enabled, the unit will sound an alarm and go into a 90-second lockdown for 90 seconds when an incorrect code is entered three times.)



E3 Direct Programming / Unit Configuration

Green arrow indicates "good" tone on unit.
Always wait for good tone before moving on.

Toggle Silent Mode

(Toggles Silent Mode, which mutes all audible-tone feedback on unit)

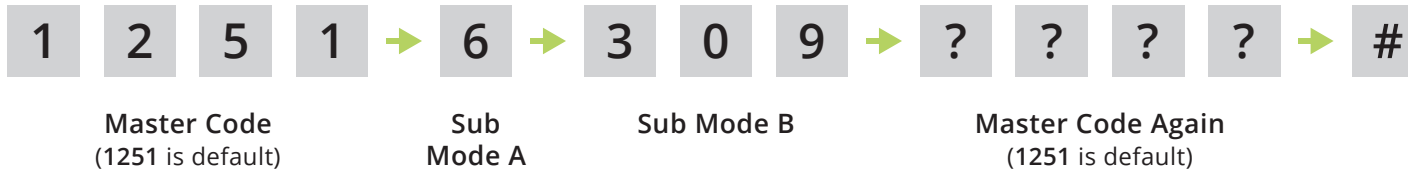

Configure Event Input 1

(Allows an external device to affect keypad operation or trigger a relay. To configure additional inputs, use the Edge Smart Keypad app.)

Mode 1 - Remote Open Mode

Triggers either Relay A or Relay B when event input state changes from normally open (N/O) to normally closed (N/C).

Mode 2 - Log Mode

Makes log entry of event input state when event input state changes from normally open (N/O) to normally closed (N/C).

Mode 3 - Remote Open and Log Mode

Combines Modes 1 and 2.

Mode 4 - Arming Circuit Mode

Enables either Relay A or Relay B when event input state changes from normally open (N/O) to normally closed (N/C). Otherwise, selected relay is disabled.

Mode 5 - Remote Operation Mode

Triggers or latches either Relay A or Relay B when event input state changes from normally closed (N/C) to normally open (N/O).

Mode 0 - Event Input 1 Disabled

Modes 1, 3, and 4

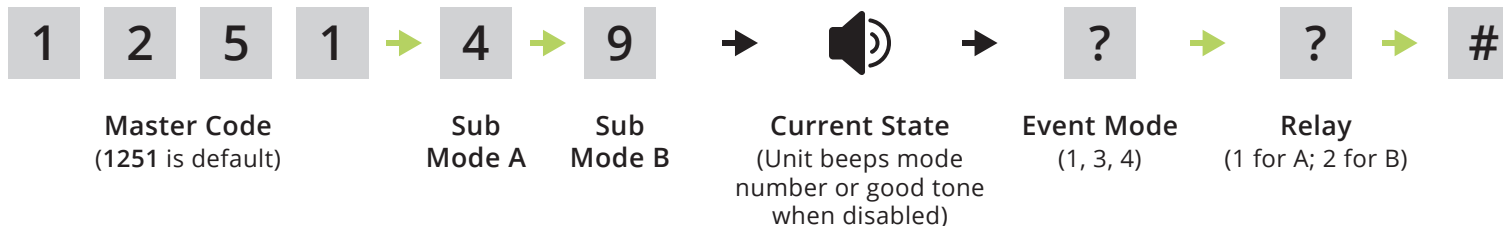

E4 Direct Programming / Unit Configuration

Green arrow indicates "good" tone on unit.
Always wait for good tone before moving on.

Configure Event Input 1 (continued)

(Allows an external device to affect keypad operation or trigger a relay. To configure additional inputs, use the Edge Smart Keypad app.)

Mode 2

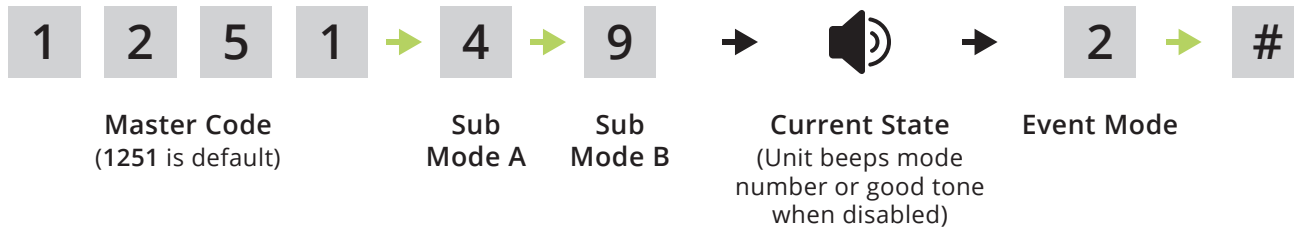

Mode 5

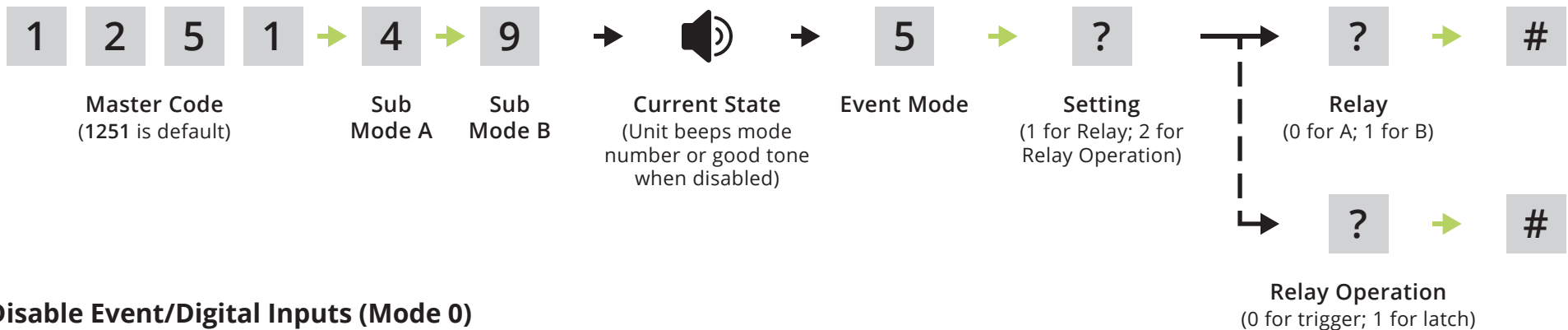

Disable Event/Digital Inputs (Mode 0)

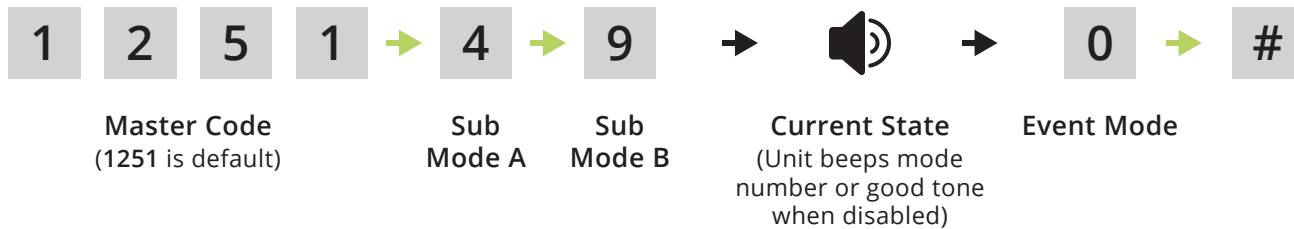

E5 Direct Programming / Unit Configuration

Green arrow indicates "good" tone on unit. Always wait for good tone before moving on.

Configure Wiegand Input

(Allows enabling or disabling of a Wiegand input and configuration of the Wiegand device type. For the tag reader type, use the Edge Smart Keypad app.)



Change Default Facility Code



F1 Direct Programming / Onboard Keypad

Green arrow indicates "good" tone on unit. Always wait for good tone before moving on.

Add Access Code(s) to Relay B

(To add multiple codes, enter each of them before pressing pound key)

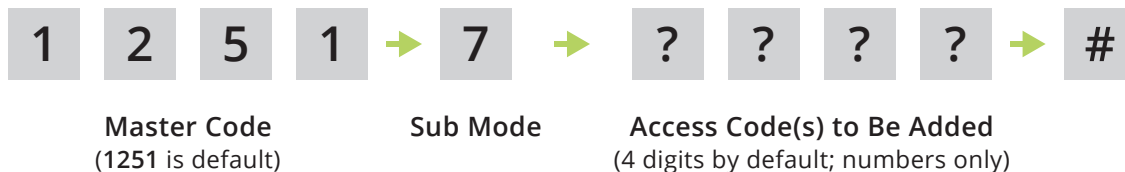

By default, these codes are unavailable for use: 1251, 1273, 1366, 1381, 1387, 1678, 1752, 1985.

F2 Direct Programming / Onboard Keypad

Green arrow indicates "good" tone on unit. Always wait for good tone before moving on.

By default, these codes are unavailable for use: 1251, 1273, 1366, 1381, 1387, 1678, 1752, 1985.

Add Latch Code to Relay A

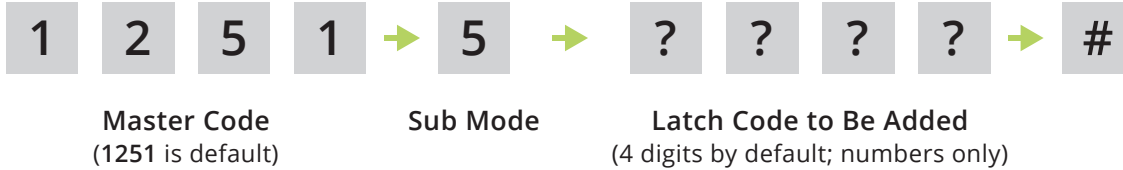

Add Latch Code to Relay B

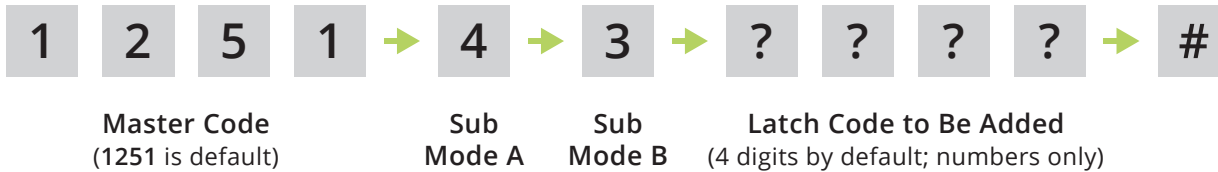

Delete Code (Non-Wiegand)

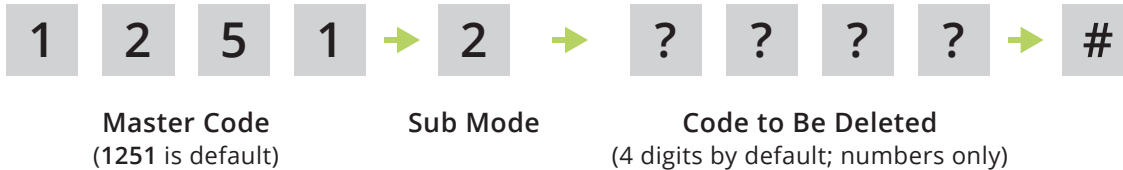

Add Limited-Use Code

(Access codes can be given a use or time restriction. For more advanced time restrictions, use the Edge Smart Keypad app.)

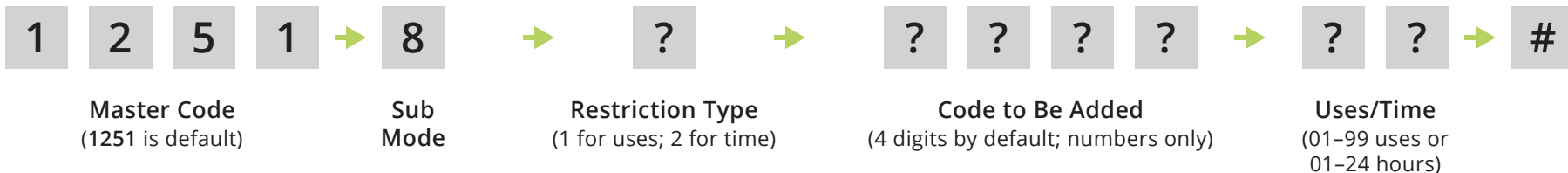

G1 Direct Programming / External Wiegand Keypad

Green arrow indicates "good" tone on unit. Always wait for good tone before moving on.

Add Wiegand Keypad Access Code(s)

(Uses default facility code; to add multiple codes, enter each of them before pressing pound key)

On Both Wiegand Inputs

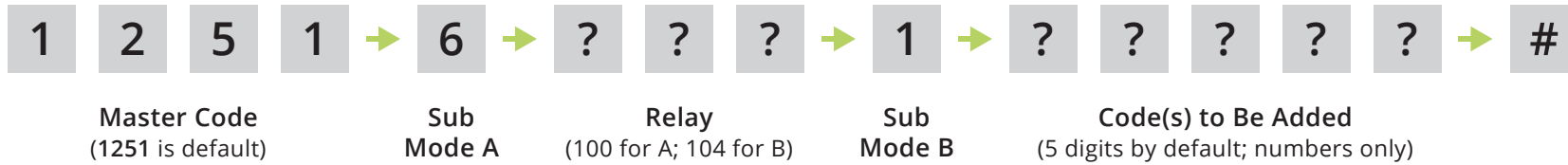

On Wiegand Input 1 or 2

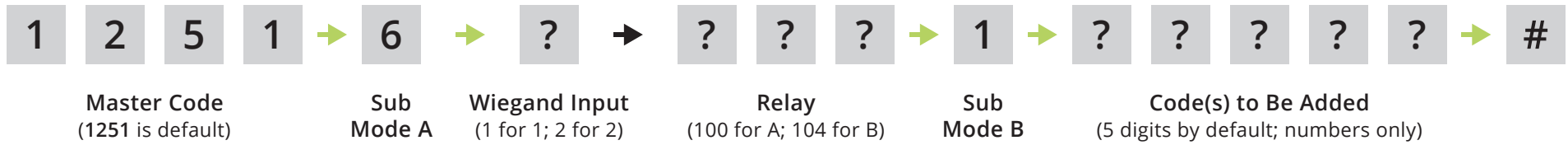

Add Wiegand Keypad Manager Access Code(s)

(Uses default facility code; to add multiple codes, enter each of them before pressing pound key)

On Both Wiegand Inputs

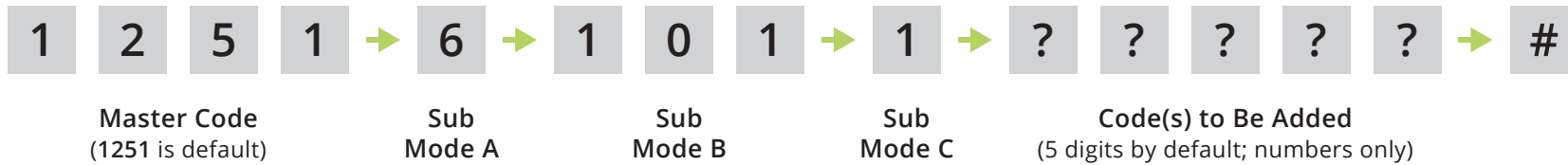

On Wiegand Input 1 or 2

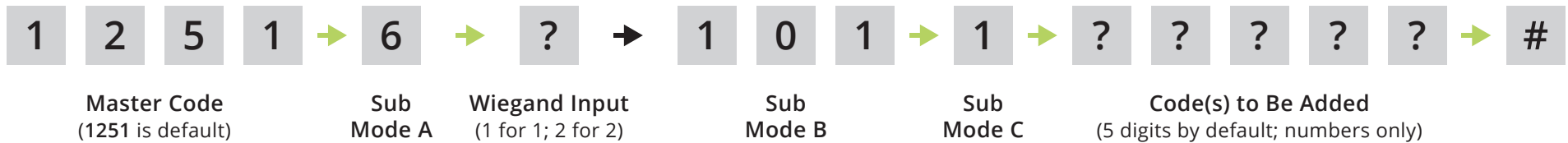

G2 Direct Programming / External Wiegand Keypad

Green arrow indicates "good" tone on unit.
Always wait for good tone before moving on.

Add Wiegand Keypad Latch Code(s)

(Uses default facility code; to add multiple codes, enter each of them before pressing pound key)

On Both Wiegand Inputs

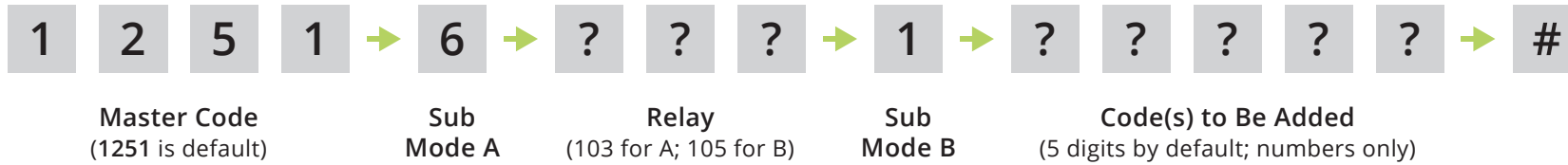

On Wiegand Input 1 or 2

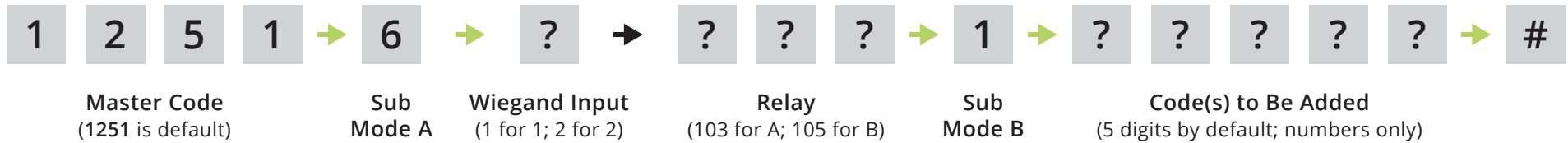

Delete Wiegand Keypad Code(s)

(Uses default facility code; to delete multiple codes, enter each of them before pressing pound key)

On Both Wiegand Inputs

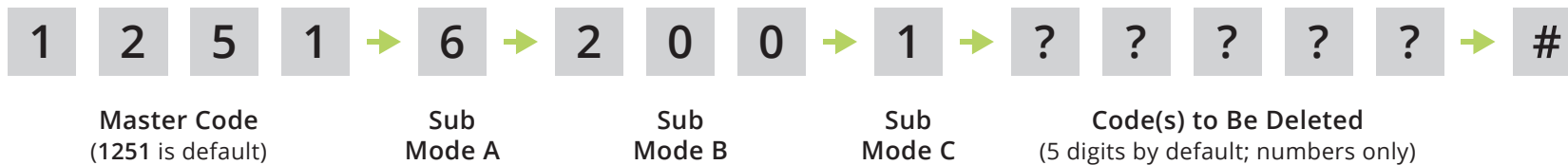

On Wiegand Input 1 or 2

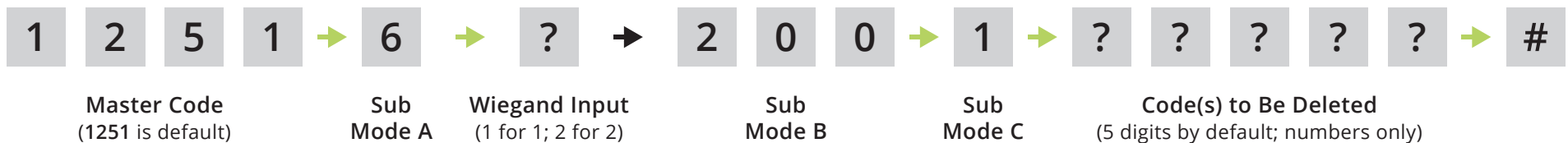

H1 Direct Programming / Wiegand Card Reader

Green arrow indicates "good" tone on unit. Always wait for good tone before moving on.

Add Wiegand Card/Remote/Vehicle Tag Access Code(s)

(To add multiple codes, enter each of them before pressing pound key)

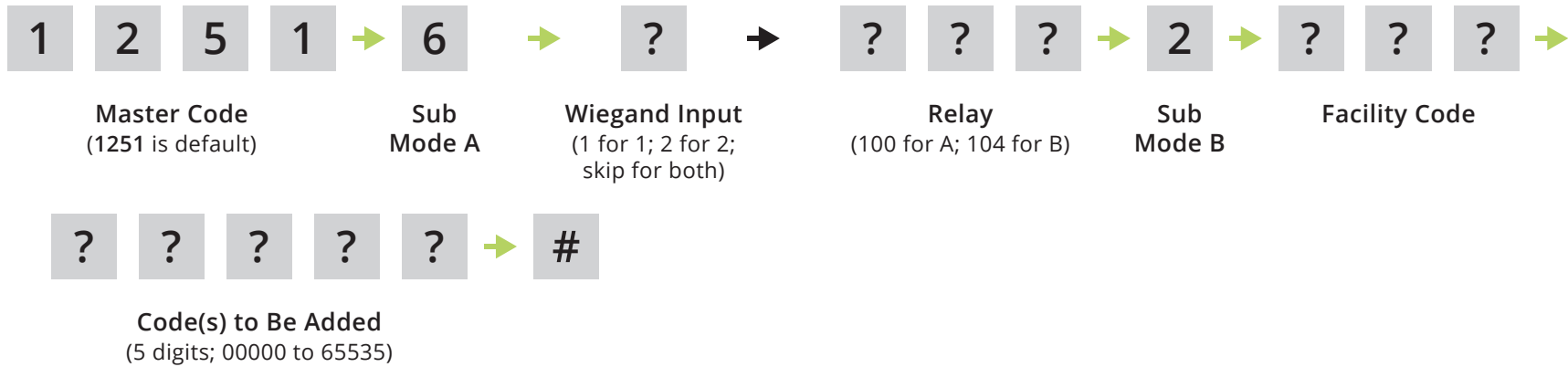

Bulk Add Wiegand Card/Remote/Vehicle Tag Access Code(s)

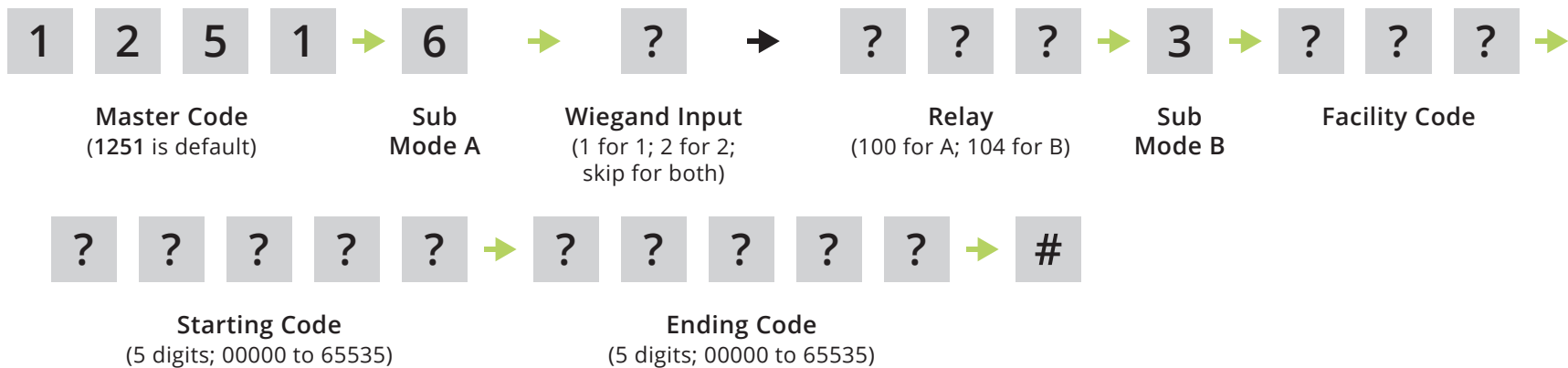

H2 Direct Programming / Wiegand Card Reader

Green arrow indicates "good" tone on unit.
Always wait for good tone before moving on.

Add Wiegand Card/Remote/Vehicle Tag Latch Code(s)

(To add multiple codes, enter each of them before pressing pound key)

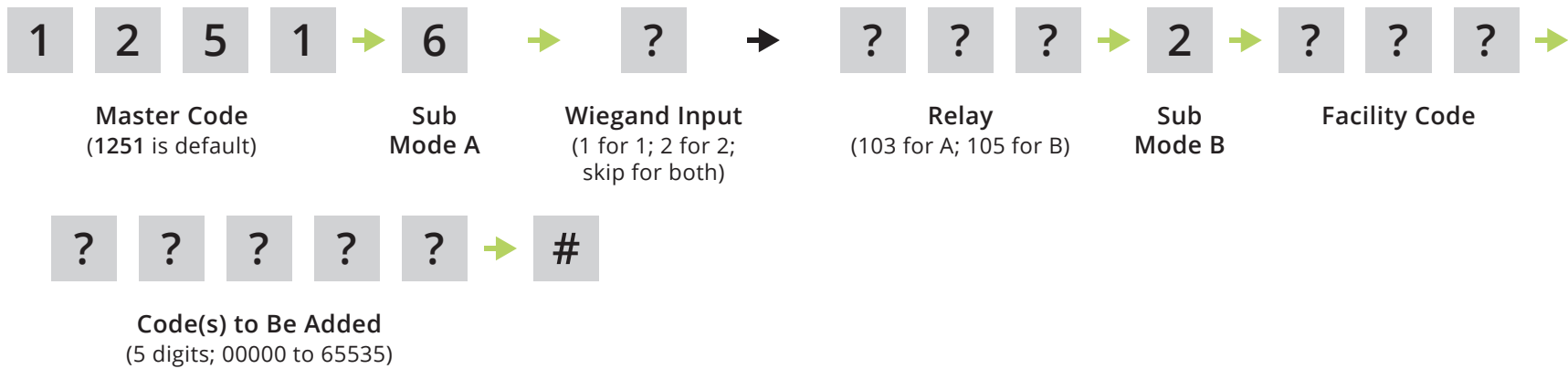

Bulk Add Wiegand Card/Remote/Vehicle Tag Latch Code(s)

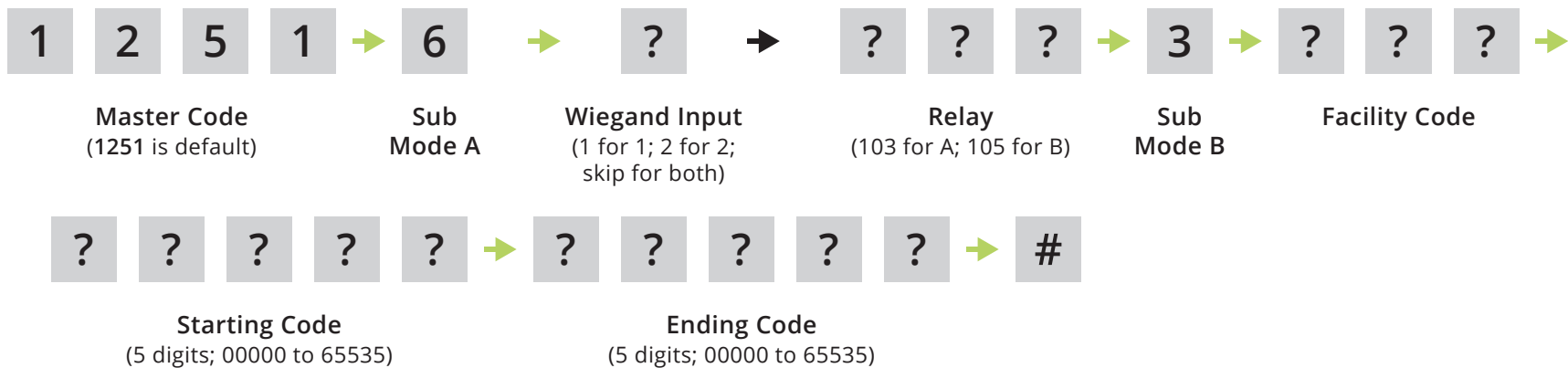

H3 Direct Programming / Wiegand Card Reader

Green arrow indicates "good" tone on unit.
Always wait for good tone before moving on.

Add Wiegand Card/Remote/Vehicle Tag Manager Access Code(s)

(To add multiple codes, enter each of them before pressing pound key)

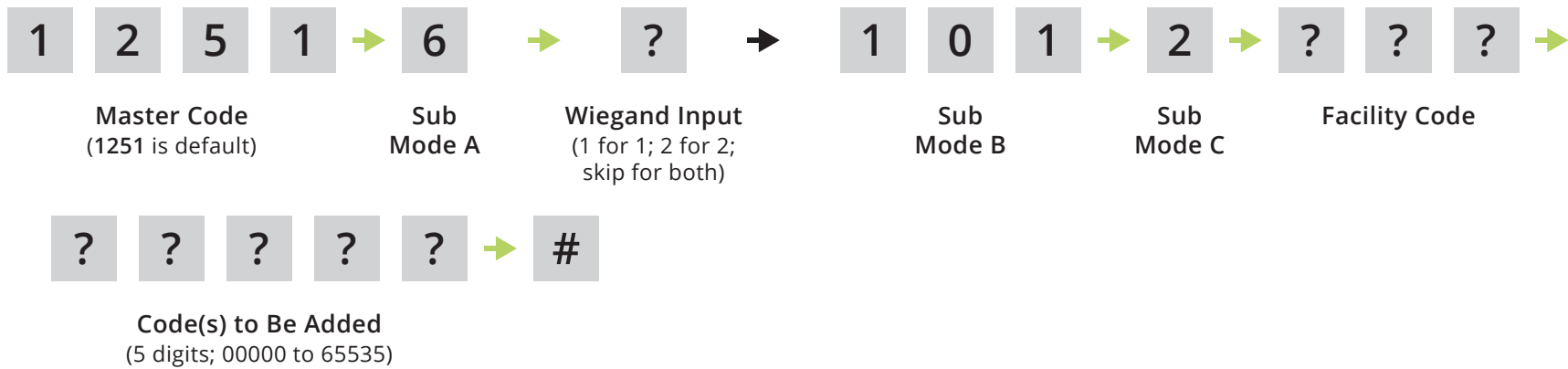

Bulk Add Wiegand Card/Remote/Vehicle Tag Manager Access Code(s)

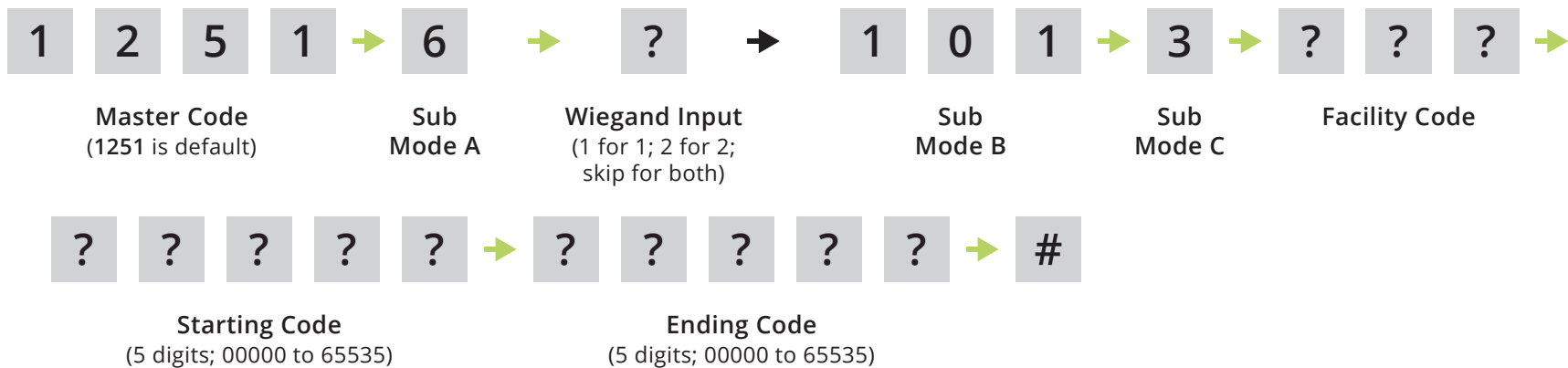

H4 Direct Programming / Wiegand Card Reader

Green arrow indicates "good" tone on unit.
Always wait for good tone before moving on.

Delete Wiegand Card/Remote/Vehicle Tag Manager Code(s)

(To add multiple codes, enter each of them before pressing pound key)

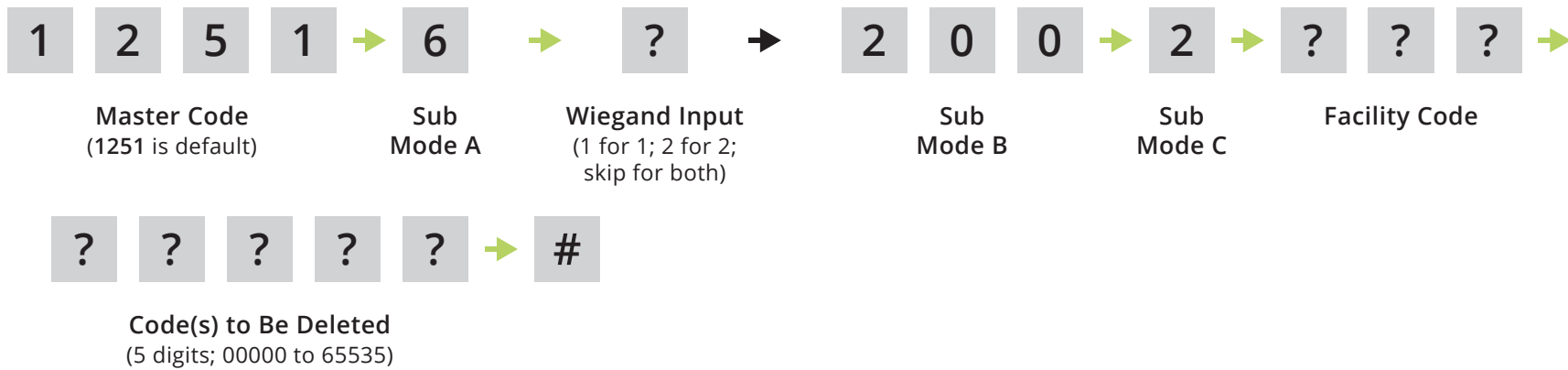

Bulk Delete Wiegand Card/Remote/Vehicle Tag Code(s)

